



# TOPBON Mechanical Seals

## Ningbo Topbon Mechanical Seals Factory

Add: Rongjiang Industrial , Jiangshan Town, Yinzhou, Ningbo, Zhejiang, China  
Website: [www.topbonseal.com](http://www.topbonseal.com)  
Tel: 0086-574-88120885  
Fax: 0086-574-88120887  
Mobile: +86-13486694050  
E-mail: [seven@topbonseal.com](mailto:seven@topbonseal.com)  
MSN: [topbonseal@hotmail.com](mailto:topbonseal@hotmail.com)  
Skype: [huanghaibocene1123](https://www.skype.com/people/huanghaibocene1123)



## Company Introduction

NINGBO TOPBON MECHANICAL SEALS FACTORY is specialized manufacturer and exporter of Mechanical seals .

Because of more than twenty years experiences , TBMS becomes the leading manufacturer of mechanical seals in China for pumps, mixers, agitators ,compressors...etc. in domestic and overseas customers from USA, Europe, South Africa and Southern Asia...etc. Our seals are similar to John Crane's, NSO's , Burgmann's and Pacific's seals and can be interchangeable. If you are used to use the above seals, then our seals must be meet your requirements. We are also can design and manufacture according to customers' drawings or samples , please contact us for details.

Since forming, the TBMS Seals philosophy has been to offer our customers the highest standards of product quality and service at competitive prices.

### 1. How to guarantee the highest standards of product quality ?

Using modern CNC-Production facilities and the strictest of quality control procedures as well as extensive product testing, ensures the highest performance standards of every mechanical seal. These standards guarantee the highest degree of reliability and provide an exceptional maintenance record for our customers.

### 2. Why we can service at competitive prices ?

whether you require a simple O Ring or a conversion from gland packing to the latest generation of mechanical seals, we believe we are in a position to offer a competitively priced product range unique in the industry to suit your needs. What's more !!! We are in Ningbo ,CHINA---The factory of the world !!! Of course we have the price preponderance.

### 3. How we packing ?

We pay special attention on packing as Mechanical Seal Components are very Delicate & Fragile. We pack goods in many layers before putting in box to avoid any breakage during logistic. Every component is marked with full details to avoid any problem to the receiver, store & inspection agencies at client's site.

### 4. How we deliver to you ?

We assure the fast despatches, which are Ex- Stock most of the time. With the help of past experience, management background and customer suggestions, we adopted special inventory program to component level to ensure best possible delivery. We also manufacture non- standard Mechanical Seals at short notice .

### 5. What about the after Sales Service ?

Our engineers are trained properly to tackle all service problems effectively and promptly. We are committed to attend all service problems of our customers at a short notice and provide necessary spares immediately. Our Engineers also provide training to maintenance staff of customer to handle emergency.



# TOPBON THE SIX SUPERIORITY

Compare to others same mechanical seal' s manufactory , TOPBON are more professional .

## 1 Ten years concentrated, whole world sales

Concentrate on designing and producing mechanical seals for more than 10 years , cooperation and serve with 26 countries , more than 100 customers all over the world.



## 2 High quality products, lowest price provided

10 years' supply chain management experience for mechanical seals, a strategic cooperative relations with several well-known raw material manufacturer, therefore we can control from the source to the final products, making our customers get the most reasonable price , also the best quality seals.

## 3 Strict quality standard

Strictly enforce TOPBON QUALITY STANDARD , using the seal rings' flatness checker ,roughness checker,spring pressure checker and some others inspection and testing equipment , to ensure every single mechanical seals up to standard

## 4 Seven days fast delivery

More than 20000 pcs of different spare parts' stock, we promised that the standard type seals' order can be finished in 7 days , making the purchasing more faster , more convenience.



## 5 Free samples provided

Free sample supply ! We can supply the standard mechanical seal' s sample for our customer' s request .

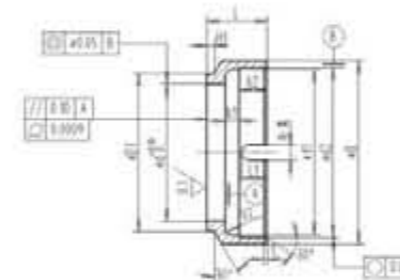

## 6 Cutomized as per technical need

We can do the seals according to your technical requirements ! -- we have professional technician and perfect products' development system, already serving more than 50 customers , customized more than 100 kinds nonstandard mechanical seals.



# TOPBON **FIVE** GUARANTEE

## 1 Quality Guarantee

Our inspection facility ensures all incoming products conform to specified requirements. Through the sealing ring flatness detection, roughness testing, spring pressure testing and testing equipment, to ensure that each set of mechanical seal is 100% qualified. We also can provide free samples of conventional products according to your needs, to make your purchase more assured.



## 2 Price Guarantee

Has 10 years of mechanical seal supply chain management experience, with a number of well-known manufacturers of raw materials to achieve strategic cooperation, truly let you use the most reasonable price, to get the best quality products.

## 3 Delivery Guarantee

We have 20000 kinds of spare parts inventory, the conventional products' delivery time can be within 7days, make the purchase more efficient, more convenient.



## 4 Vendor Managed Inventory Guarantee

Our Vendor Managed Inventory (VMI) assures you' ll always have the parts you need. We can stock your specified parts, often ready for same day shipping. We maintain the inventory levels according to your needs.



## 5 Service Guarantee

Commitment: reply within 8 hours, quote within 24 hours.

We have English, Russian, Spanish professional sales, and every country has a special responsibility for the business, to make sure that your needs can be better met.



# MATERIAL CODES

Metal Materials (结构件材料)			
Type (材料类型)	Material Description (材料描述)	Symbol (简写)	Code (代号)
	Normal Stainless Steel —— 普通不锈钢	2Cr13	F2
	Stainless Steel —— 不锈钢	304	F
	Stainless Steel —— 不锈钢	304L	F1
	Stainless Steel —— 不锈钢	316	G
	Stainless Steel —— 不锈钢	316L	G1
	Hastelloy C-4 Alloy —— 哈氏合金	Hast.C4	M
	Hastelloy B-2 Alloy —— 哈氏合金	Hast.B2	M1
	Carpenter —— 卡彭特	Carp.20	M3
	Monel —— 蒙乃尔	Monel.K50	M4
	Hastelloy C-276 Alloy —— 哈氏合金	Hast.C-276	M5
	Pure Titanium —— 纯钛	TA2	T2
	Carpenter —— 卡彭特	Carp.42	T4
	Deposit induration Stainless Steel —— 沉淀硬化不锈钢	Am350	T6
	08F Coated with Chrome —— 08F镀铬	Q235-A	C
	Brass —— 黄铜	H62	H

Secondary Seal Materials (辅助密封件材料)			
Type (材料类型)	Material Description (材料描述)	Symbol (简写)	Code (代号)
Rubber (橡胶类)	Nitrile (NBR) —— 丁腈橡胶	NBR	P
	Ethylene Propylene (EPDM) —— 乙丙橡胶	EPR	E
	Fluorocarbon rubber (Viton) —— 氟橡胶	FPM	V
	Silicon Rubber —— 硅橡胶	SI	S
	Chloroprene rubber —— 氯丁橡胶	CR	N
	Hydrogen Nitrile —— 氢化丁腈	HNBR	H
	Perfluoroelastomer (Kalrez, Chemraz) —— 全氟橡胶	FFKM	K
PTFE (聚四氟乙烯类)	Pure PTFE —— 纯聚四氟乙烯	PTFE	T
	PTFE, glassfibre reinforced —— 四氟填充玻璃纤维		T2
	PTFE, carbon reinforced —— 四氟填充碳纤维		T3
PTFE wrapped (聚四氟乙烯覆层类)	FPM, with PTFE wrapped —— 四氟包覆氟橡胶	PTFE+FPM	M1
	EPR, with PTFE wrapped —— 四氟包覆乙丙橡胶	PTFE+EPR	M2
	MVQ, with PTFE wrapped —— 四氟包覆硅橡胶	PTFE+WVQ	M3
Expanded graphite (柔性石墨类)	Expanded graphite —— 柔性石墨		G



# CATALOGUE

Seal Ring Materials (密封环材料)			
Type (材料类型)	Material Description (材料描述)	Symbol (简写)	Code (代号)
SiC (碳化硅类)	Silicon Carbide, Sintered Pressureless —— 无压烧结碳化硅	SSIC	Q1
	Silicon Carbide, Sintered Pressureless (shrunk-in) —— 无压烧结碳化硅镶装		Q12
	Silicon Carbide, Reaction bonded —— 反应烧结碳化硅	RBSIC	Q2
	Silicon Carbide, Reaction bonded (shrunk-in) —— 反应烧结碳化硅镶装		Q22
	Reaction Silicon Carbide with Graphite —— 反应烧结碳化硅加石墨		Q3
	Sintered Silicon Carbide with SB —— 无压烧结碳化硅加石墨		Q4
Al2O3 (氧化铝类)	Ceramic (Alumina) —— 氧化铝	99.5%Al2O3	V
	Ceramic (Alumina) —— 氧化铝	99%Al2O3	V1
	Ceramic (Alumina) —— 氧化铝	95%Al2O3	V2
	Cermet —— 金属陶瓷	Fe+Al2O3	V3
TC (硬质合金类)	Co-binder Tungsten Carbide —— 钴基硬质合金	YG6, YG8	U1
	Co-binder Tungsten Carbide (shrunk-in) —— 钴基硬质合金镶装		U12
	Ni-binder Tungsten Carbide —— 镍基硬质合金	M106, M108	U2
	Ni-binder Tungsten Carbide (shrunk-in) —— 镍基硬质合金镶装		U22
	NiCrMo-binder Tungsten Carbide —— 镍铬基硬质合金	W7	U3
	NiCrMo-binder Tungsten Carbide (shrunk-in) —— 镍铬基硬质合金镶装		U32
Carbon (石墨类)	Antimony Impreg. Carbon Graphite —— 浸锑石墨		A
	Babbit Alloy Impreg. Carbon Graphite —— 浸巴氏合金石墨		A1
	Copper Impreg. Carbon Graphite —— 浸铜石墨		A2
	Resin Impreg. Carbon Graphite (Furan) —— 浸呋喃树脂石墨		B
	Resin Impreg. Carbon Graphite (Epoxy) —— 浸环氧树脂石墨		B1
	Resin Impreg. Carbon Graphite (Phedol-formaldehyde) —— 浸酚醛树脂石墨		B2
	Hot-pressing Carbon —— 热压石墨		B5
Metal (金属类)	Stainless Steel —— 不锈钢	304	F
	Stainless Steel —— 不锈钢	304L	F1
	Stainless Steel —— 不锈钢	316	G
	Stainless Steel —— 不锈钢	316L	G1
	Tin bronze —— 锡青铜	ZQSn6-6-3	S1
	High silicon cast iron —— 高硅铸铁		S2
	High nickel cast iron —— 高镍铸铁		S3
Plastic (塑料类)	PTFE, glassfibre reinforced —— 四氟填充玻璃纤维		Y1
	PTFE, carbon reinforced —— 四氟填充碳纤维		Y2

Spring Materials (弹簧材料)			
Type (材料类型)	Material Description (材料描述)	Symbol (简写)	Code (代号)
	Hastely C-4 Alloy —— 哈氏合金	Hast.C4	M
	Stainless Steel —— 不锈钢	304	F
	Stainless Steel —— 不锈钢	304L	F1
	Stainless Steel —— 不锈钢	316	G
	Stainless Steel —— 不锈钢	316L	G1
	65Mn Coated with Chrome —— 65Mn镀铬	65Mn	G8

Seat Series								Page1-14
TOPBON	AES	VUCAN	BURGMANN	CRANE	ROTEN	STERLING	FLOWSERVE	PAGE
TBG6/G606	S03	8.DINS	G6/G606	BS	-	SM32DINS	8S	01
TBG4	S01	8.STD	G4	-	-	-	-	01
TBT24DINS	S06	24.DINS	-	BO	-	522DINS	4S	02
TBBO	S06	24.DINS	-	BO	-	522DINS	4S	02
TBBS	S03	8.DINS	G6	BS	-	SM32DINS	8S	03
TBG13	-	-	G13	-	-	-	-	03
TBT12	-	12	-	-	-	-	-	04
TB7D	-	12DIN	-	-	-	-	-	04
TBBC	-	-	-	BC	-	-	-	05
TBG9/G92	S02	8.DINL	G9/G92	-	-	SM32DINL	8L	05
TBG16	-	-	G16	-	-	-	-	06
TBG46	-	-	G46	-	-	-	-	06
TB24DINL	S05	24.DINL	-	-	-	522DINL	4L	07
TBBD	S010	-	-	BD	-	-	-	07
TBN	-	-	-	PG	-	-	-	08
TBT20	S07/S070	21	-	W TYPE	W	-	1H	08
TBT21	S07/S070	31	-	W TYPE	W	-	1H	09
TBCG60	-	-	G60	-	-	-	-	09
TBCT20	-	20(Metric)	-	-	-	-	-	10
TBCT20-1	-	20(Inch)	-	-	-	-	-	10
TBCT24	-	24	-	-	-	-	-	11
TBT11	-	11	-	-	-	-	-	11
TBL210	-	-	-	2100	-	-	-	12
TB8P	S010	-	-	BP	-	-	-	12
TB16	-	-	-	AG	-	-	-	13
TB25	S08/S080	25	-	V	V	T	-	14
TB27	-	27	-	-	-	-	-	14

O-ring Mechanical Seals								Page15-36
TOPBON	AES	VUCAN	BURGMANN	CRANE	ROTEN	STERLING	FLOWSERVE	PAGE
TB17D	-	7D	-	-	-	-	-	15
TB41	-	-	-	-	-	-	-	15
TB80	T01	8	M32/M377	-	L4B	SM32	38	16
TB80D	T01D	8.DIN	M32N/M377N	-	-	SM32N	38D	16
TB120	T03	12	BT-RN	-	2	SR2	42	17
TB120D	T03D	12.DIN	BT-RN.NU	-	UNITEN 2	SU2	42D	17
TB155/155A	-	-	BT-FN	-	-	-	-	18
TBM2N	T07D	-	M2N	-	UNITEN 22	-	-	18
TBM3/M3A	-	-	M3N	-	-	-	-	19
TBM37/M37G	-	-	M37/M37G	-	-	-	-	19
TB250	-	-	-	-	-	-	-	20



TOPBON	AES	VUCAN	BURGMANN	CRANE	ROTEN	STERLING	FLOWSERVE	PAGE
TB980	P080	98	-	-	-	-	-	20
TB950	P08	95	-	R00	-	-	-	21
TB960	-	96	-	-	-	-	-	22
TB970	-	97	-	-	-	-	-	23
TB1527	-	-	-	-	-	-	-	24
TBUS2	-	-	-	-	-	-	-	24
TB8-1	M01S	1609S	-	8-1	-	290S	-	25
TB8-1T	M05S	1645S	-	8-1T	-	294S	-	25
TB8B1	M02S	1609BS	-	8B1	-	290BS	-	26
TB8BT	-	-	-	8B1T	-	-	-	26
TB40	-	40	-	-	-	-	-	27
TB58B	M04S	1659BS	BT-C5.KB	58B	-	259BS	-	27
TB58U	M03S	1659S	BT-C5.KU	58U	-	259S	-	28
TB67	W07DM	1677	M7NM78N	-	-	270	Europac 600	28
TB68	W01	1688	-	80(DF/FP)	7K	280	168	29
TB68A	W01-TL	-	M7KS60	-	-	-	-	29
TB68B	W03	1688W	-	87(E/VEC)	-	280W/282	-	29
TB68C	W02	1688L	-	-	UNITEN 7K	280L	-	30
TB68D	W03S	1688W	-	87(E/VEC)	-	280W/282	-	30
TB68E	W04	1688Y	-	-	-	280Y	-	30
TB82	-	-	-	-	-	-	-	31
TB92N	M010	-	HJ92N	-	EHS	-	-	31
TB491	-	-	-	-	-	-	-	32
TB591	-	-	-	-	-	-	-	32
TB891	-	-	-	-	-	-	-	33
TBRO-A	-	-	-	-	-	-	-	33
TBRO-B	-	-	-	-	-	-	-	34
TBRO-C	-	-	-	-	-	-	-	34
TBMTN	-	-	M7N	-	-	-	-	35
TBH7N	-	-	H7N	-	-	-	-	35
TBM74A	-	-	M74-D	-	-	-	-	36
TBM74D	-	-	H74-D	-	-	-	-	36

**Elastomer Bellow Mechanical Seals Page37-47**

TOPBON	AES	VUCAN	BURGMANN	CRANE	ROTEN	STERLING	FLOWSERVE	PAGE
TB1	P05U	A5	MG901/D1-G55	1(US)	-	-	51	37
TB1A	-	-	-	1A	-	-	-	37
TB1B	-	-	-	1B	-	-	-	38
TB2	P04U	A4	-	2(US)	-	-	52	38
TB20/20T	P02/P02T	20	MG920/D1-G50	2(N SEAT)	21	212	200	39
TB21/21T	P04/P04T	11	-	21	21A	212A	110	39
TB24	P03	24	MG912/D1-G60	521	52/L4K	522	240	40
TB560A	-	-	-	-	-	-	-	40
TBFBD	-	-	-	-	-	-	-	41
TBBIA	-	-	-	-	-	-	-	41
TBMG912	-	-	MG9	-	-	-	-	42
TB6	-	-	-	-	-	-	-	43
TB60/65	B04/B04U	60/65	BT-PNT	106	16	216/217	160	43

TOPBON	AES	VUCAN	BURGMANN	CRANE	ROTEN	STERLING	FLOWSERVE	PAGE
TB140/142/143	-	14/142/143	-	-	-	-	-	43
TB150	BP02	1520(Metric)	MG1S20	2(N SEAT)	-	152	150	44
TB150A	BP02	1520(Inch)	MG1S20	2(N SEAT)	-	152	150	44
TB151/152	BP04/BP05	1511/1522	-	21/1(N SEAT)	-	151A/152A	151/152	45
TB210	B05	14DIN	-	2100	-	540	140	45
TBMG1/MG12/MG13/MGS20	B02/B012/B01	19/192/193	MG1/12/13/S20	-	L3/L3K/L3	SMG1/12/1	190/192/193	46
TB301	-	-	-	-	-	-	-	46
TB502	B07	1724	-	502	-	524	-	47
TB70	-	-	-	-	-	-	-	47

**PTFE Wedge Mechanical Seals Page48-51**

TOPBON	AES	VUCAN	BURGMANN	CRANE	ROTEN	STERLING	FLOWSERVE	PAGE
TBWB2	-	-	-	-	-	-	-	48
TB9	M01	1609	-	9	90	290	-	48
TB9B	M02	1609B	-	9B	-	290B	-	49
TB9T	M05	1645	-	9T	-	294	-	49
TB9BT	M06	1645B	-	9BT	-	294B	-	50
TB59B	M04	1659B	BT-C56.KB	59B	-	259B	-	50
TB59U	M03	1659	BT-C56.KU	59U	-	259	-	51

**Cartridge Mechanical Seals Page52-56**

TOPBON	AES	VUCAN	BURGMANN	CRANE	ROTEN	STERLING	FLOWSERVE	PAGE
TBL9	CS	-	-	-	-	-	-	52
TBCARTEX-SN	-	-	CARTEX-SN	-	-	-	-	52
TBGU	-	-	-	4610	-	-	-	53
TBGU0	CDSA	-	-	-	-	-	-	54
TBGU1	CURC	-	-	-	-	-	-	55
TBGU2	CONII	-	-	-	-	-	-	56

**Metal Bellow Mechanical Seals Page57-58**

TOPBON	AES	VUCAN	BURGMANN	CRANE	ROTEN	STERLING	FLOWSERVE	PAGE
TB685	-	-	MFL85N	-	-	-	-	57
TB686	-	-	MFLWT80	-	-	-	-	57
TB687	-	-	-	680	-	-	-	58
TB688	-	-	-	609	-	-	-	58

**Mechanical Seal For Alfa Laval Pump Page59**

**Mechanical Seal For GRUNDFOS Pump Page60**

**Mechanical Seal For FLYGT Pump Page61-62**

**FLYGT Plug-in Seal Page63**

**Mechanical Seal For APV Pump Page64**

**Mechanical Seal For O.E.M Pump Page65**

**Mechanical Seal For FRISTAM Pump Page66**



TBG6 / G606

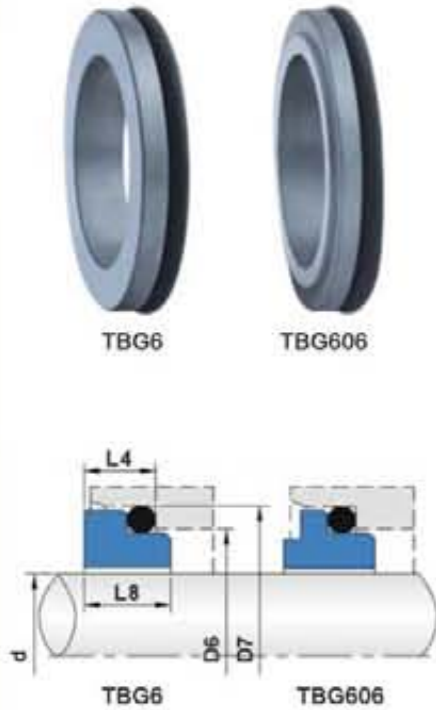

规格/Size (公制/Metric)	d	D6	D7	L4	L8
10	10	17	21	6.6	7.5
12	12	19	23	6.6	7.5
14	14	21	25	6.6	7.5
16	16	23	27	6.6	7.5
18	18	27	33	7.5	8.5
20	20	29	35	7.5	8.5
22	22	31	37	7.5	8.5
24	24	33	39	7.5	8.5
25	25	34	40	7.5	8.5
28	28	37	43	7.5	8.5
30	30	39	45	7.5	8.5
32	32	42	48	7.5	8.5
33	33	42	48	7.5	8.5
35	35	44	50	7.5	8.5
38	38	49	56	9.0	10.0
40	40	51	58	9.0	10.0
43	43	54	61	9.0	10.0
45	45	56	63	9.0	10.0
48	48	59	66	9.0	10.0
50	50	62	70	9.5	10.5
53	53	65	73	11.0	12.0
55	55	67	75	11.0	12.0
58	58	70	78	11.0	12.0
60	60	72	80	11.0	12.0
63	63	75	83	11.0	12.0
65	65	77	85	11.0	12.0
68	68	81	90	11.3	12.5
70	70	83	92	11.3	12.5
75	75	88	97	11.3	12.5
80	80	95	105	12.0	13.0
85	85	100	110	14.0	15.0
90	90	105	115	14.0	15.0
95	95	110	120	14.0	15.0
100	100	115	125	14.0	15.0

TBG4

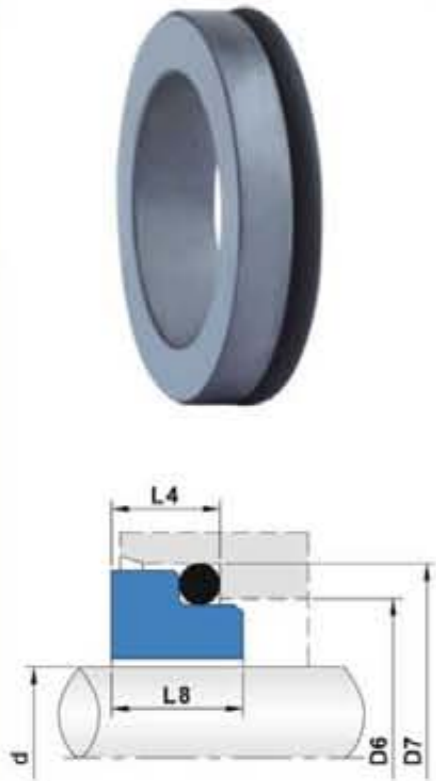

规格/Size (公制/Metric)	d	D6	D7	L4	L8
10	10	15.5	19.2	6.6	7.5
12	12	17.5	21.6	6.6	7.5
14	14	20.5	24.6	6.6	7.5
15	15	20.5	24.6	6.6	7.5
16	16	22.0	28.0	7.5	8.5
18	18	24.0	30.0	8.0	9.0
20	20	29.5	35.0	7.5	8.5
22	22	29.5	35.0	7.5	8.5
24	24	32.0	38.0	7.5	8.5
25	25	32.0	38.0	7.5	8.5
26	26	34.0	40.0	8.0	9.0
28	28	36.0	42.0	9.0	10.0
30	30	39.2	45.0	10.5	11.5
32	32	42.2	48.0	10.5	11.5
33	33	44.2	50.0	11.0	12.0
35	35	46.2	52.0	11.0	12.0
38	38	49.2	55.0	10.3	11.3
40	40	52.2	58.0	10.8	11.8
42	42	53.3	62.0	12.0	13.2
43	43	53.3	62.0	12.0	13.2
45	45	55.3	64.0	11.6	12.8
48	48	59.7	68.4	11.6	12.8
50	50	60.8	69.3	11.6	12.8
53	53	63.8	72.3	12.3	13.5
55	55	66.5	75.4	13.3	14.5
58	58	69.5	78.4	13.3	14.5
60	60	71.5	80.4	13.3	14.5
63	63	74.5	83.4	13.3	14.2
65	65	76.5	85.4	13.0	14.2
68	68	82.7	91.5	13.7	14.9
70	70	83.0	92.0	13.0	14.2
75	75	90.2	99.0	14.0	15.2
80	80	95.2	104.0	15.0	16.2
85	85	100.2	109.0	14.8	16.0
90	90	105.2	114.0	14.8	16.0
95	95	111.6	120.3	15.8	17.0
100	100	114.5	123.3	15.8	17.0

TBT24DINS



规格/Size (公制/Metric)	d	D6	D7	L4	L8
10	10	17	21	8.6	10.0
12	12	19	23	8.6	10.0
14	14	21	25	8.6	10.0
16	16	23	27	8.6	10.0
18	18	27	33	10.0	11.5
20	20	29	35	10.0	11.5
22	22	31	37	10.0	11.5
24	24	33	39	10.0	11.5
25	25	34	40	10.0	11.5
28	28	37	43	10.0	11.5
30	30	39	45	10.0	11.5
32	32	42	48	10.0	11.5
33	33	42	48	10.0	11.5
35	35	44	50	10.0	11.5
38	38	49	56	11.0	12.5
40	40	51	58	11.0	12.5
43	43	54	61	11.0	12.5
45	45	56	63	11.0	12.5
48	48	59	66	11.0	12.5
50	50	62	70	13.0	14.5
53	53	65	73	13.0	14.5
55	55	67	75	13.0	14.5
58	58	70	78	13.0	14.5
60	60	72	80	13.0	14.5
63	63	75	83	13.0	14.5
65	65	77	85	13.0	14.5
68	68	81	90	15.3	16.5
70	70	83	92	15.3	16.5
75	75	88	97	15.3	16.5
80	80	95	105	15.7	17.5
85	85	100	110	15.7	17.5
90	90	105	115	15.7	17.5
95	95	110	120	15.7	17.5
100	100	115	125	15.7	17.5

TBBO



规格/Size (公制/Metric)	d	D6	D7	L4	L8
14	14	21	25	12.0	12.8
16	16	23	27	12.0	12.8
18	18	27	33	13.5	14.5
20	20	29	35	13.5	14.5
22	22	31	37	13.5	14.5
24	24	33	39	13.3	14.3
25	25	34	40	13.0	14.0
28	28	37	43	12.5	13.5
30	30	39	45	12.0	13.0
32	32	42	48	12.0	13.0
33	33	42	48	12.0	13.0
35	35	44	50	12.0	13.0
38	38	49	56	13.0	14.0
40	40	51	58	13.0	14.0
43	43	54	61	13.0	14.0
45	45	56	63	13.0	14.0
48	48	59	66	13.0	14.0
50	50	62	70	13.5	14.5
53	53	65	73	13.5	14.5
55	55	67	75	13.5	14.5
58	58	70	78	13.5	14.2
60	60	72	80	13.5	14.2
63	63	75	83	13.5	14.2
65	65	77	85	13.5	14.2
68	68	81	90	13.5	14.2
70	70	83	92	14.5	15.2
75	75	88	97	14.5	15.2
80	80	95	105	15.0	15.7
85	85	100	110	15.0	15.7
90	90	105	115	15.0	15.7
95	95	110	120	15.0	15.7
100	100	115	125	15.0	15.7



TBBS

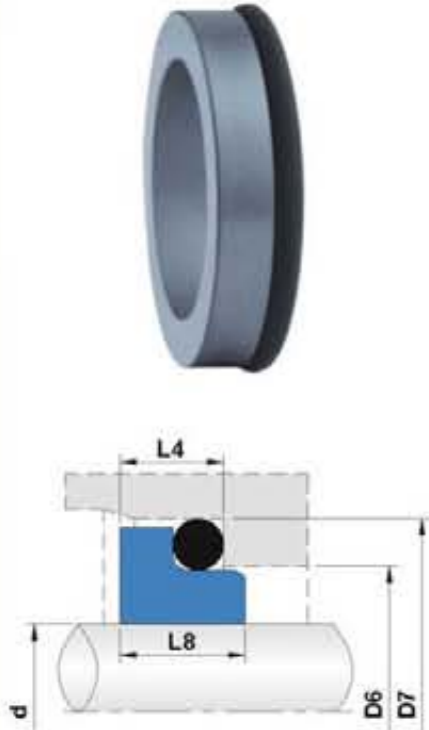

规格/Size (公制/Metric)	d	D6	D7	L4	L8
12	12	19	23	6.0	6.8
14	14	21	25	6.0	6.8
16	16	23	27	6.0	6.8
18	18	27	33	6.0	7.0
20	20	29	35	6.0	7.0
22	22	31	37	6.0	7.0
24	24	33	39	6.0	7.0
25	25	34	40	6.0	7.0
28	28	37	43	6.0	7.0
30	30	39	45	7.0	8.0
32	32	42	48	7.0	8.0
33	33	42	48	7.0	8.0
35	35	44	50	8.0	9.0
38	38	49	56	8.0	9.0
40	40	51	58	8.0	9.0
43	43	54	61	8.0	9.0
45	45	56	63	8.0	9.0
48	48	59	66	10.0	11.0
50	50	62	70	10.0	11.0
53	53	65	73	10.0	11.0
55	55	67	75	10.0	11.0
58	58	70	78	10.0	10.7
60	60	72	80	12.0	12.7
63	63	75	83	12.0	12.7
65	65	77	85	12.0	12.7
68	68	81	90	12.0	12.7
70	70	83	92	12.0	12.7
75	75	88	97	12.0	12.7
80	80	95	105	12.5	13.2
85	85	100	110	12.5	13.2
90	90	105	115	12.5	13.2
95	95	110	120	12.5	13.2
100	100	115	125	12.5	13.2

TBG13



规格/Size (公制/Metric)	d	D6	D7	L4	L8
10	10	15.5	19.2	7.1	9.0
12	12	17.5	21.6	7.6	10.0
14	14	20.5	24.6	7.6	10.0
15	15	20.5	24.6	8.6	11.0
16	16	22.0	28.0	9.0	11.5
18	18	24.0	30.0	10.0	12.5
20	20	29.5	35.0	9.5	12.5
22	22	29.5	35.0	9.5	12.5
24	24	32.0	38.0	9.5	12.5
25	25	32.0	38.0	9.5	12.5
26	26	34.0	40.0	10.0	13.0
28	28	36.0	42.0	11.0	14.0
30	30	39.2	45.0	11.0	14.0
32	32	42.2	48.0	11.0	14.0
33	33	44.2	50.0	11.5	14.5
35	35	46.2	52.0	11.5	14.5
38	38	49.2	55.0	11.5	14.5
40	40	52.2	58.0	11.5	14.5
42	42	53.3	62.0	14.3	17.0
43	43	53.3	62.0	14.3	17.0
45	45	55.3	64.0	14.3	17.0
48	48	59.7	68.4	14.3	17.0
50	50	60.8	69.3	14.3	17.0
53	53	63.8	72.3	14.3	17.0
55	55	66.5	75.4	15.3	18.0
58	58	69.5	78.4	15.3	18.0
60	60	71.5	80.4	15.3	18.0
63	63	74.5	83.4	15.3	18.0
65	65	76.5	85.4	15.3	18.0
68	68	82.7	91.5	16.0	19.0
70	70	83.0	92.0	15.3	18.0
75	75	90.2	99.0	15.3	18.0
80	80	95.2	104.0	16.3	19.0
85	85	100.2	109.0	16.3	19.0
90	90	105.2	114.0	16.3	19.0
95	95	111.6	120.3	17.3	20.0
100	100	114.5	123.3	17.3	20.0

TBT12



规格/Size (公制/Metric)	d	D6	D7	L4	L8
10	10	14.0	18.1	5.5	7.0
11	11	16.5	20.6	5.5	7.0
12	12	16.5	20.6	5.5	7.0
13	13	19.0	23.1	6.0	7.5
14	14	19.0	23.1	6.0	7.5
15	15	21.0	26.9	7.0	9.0
16	16	21.0	26.6	7.0	9.0
17	17	21.0	26.9	7.0	9.0
18	18	25.0	30.9	8.0	9.5
19	19	25.0	30.9	8.0	9.5
20	20	25.0	30.9	8.0	9.5
21	21	30.0	35.4	8.0	9.5
22	22	30.0	35.4	8.0	9.5
23	23	30.0	35.4	8.0	9.5
24	24	30.0	35.4	8.0	9.5
25	25	33.0	38.2	8.5	9.5
26	26	33.0	38.2	8.5	9.5
28	28	38.0	43.3	9.0	11.0
29	29	38.0	43.3	9.0	11.0
30	30	38.0	43.3	9.0	11.0
32	32	38.0	43.3	9.0	11.0
33	33	45.0	53.5	11.5	13.0
34	34	45.0	53.5	11.5	13.0
35	35	45.0	53.5	11.5	13.0
36	36	45.0	53.5	11.5	13.0
38	38	52.0	60.5	11.5	13.0
40	40	52.0	60.5	11.5	13.0
42	42	52.0	60.5	11.5	13.0
43	43	52.0	60.5	11.5	13.0
44	44	57.0	65.5	11.5	13.0
45	45	57.0	65.5	11.5	13.0
48	48	57.0	65.5	11.5	13.0
50	50	64.0	72.5	11.5	13.5
55	55	64.0	72.5	11.5	13.5
60	60	72.0	79.3	11.5	13.5
65	65	77.0	84.5	11.5	13.5
70	70	82.0	89.5	11.5	13.5
75	75	87.0	94.5	11.5	13.5
80	80	92.0	99.5	11.5	13.5
85	85	98.0	105.5	13.5	15.5
90	90	105.0	111.5	13.5	15.5
95	95	110.0	116.5	13.5	15.5
100	100	114.0	119.5	13.5	15.5

TB7D



规格/Size (公制/Metric)	d	D6	D7	L4	L8
10	10	17	21	7	8.5
12	12	19	23	7	8.5
14	14	21	25	7	8.5
16	16	23	27	7	8.5
18	18	27	33	10	12.0
20	20	29	35	10	12.0
22	22	31	37	10	12.0
24	24	33	39	10	12.0
25	25	34	40	10	12.0
28	28	37	43	10	12.0
30	30	39	45	10	12.0
32	32	42	48	10	11.5
33	33	42	48	10	11.5
35	35	44	50	10	11.5
38	38	49	56	13	15.0
40	40	51	58	13	15.0
43	43	54	61	13	14.5
45	45	56	63	13	14.5
48	48	59	66	13	15.0
50	50	62	70	14	16.0
53	53	65	73	14	16.0
55	55	67	75	14	16.0
58	58	70	78	14	16.0
60	60	72	80	14	16.0
63	63	75	83	14	16.0
65	65	77	85	14	16.0
68	68	81	90	16	18.0
70	70	83	92	16	18.0
75	75	88	97	16	18.0
80	80	95	105	18	20.0
85	85	100	110	18	20.0
90	90	105	115	18	20.0
95	95	110	120	18	20.0
100	100	115	125	18	20.0



TBBC

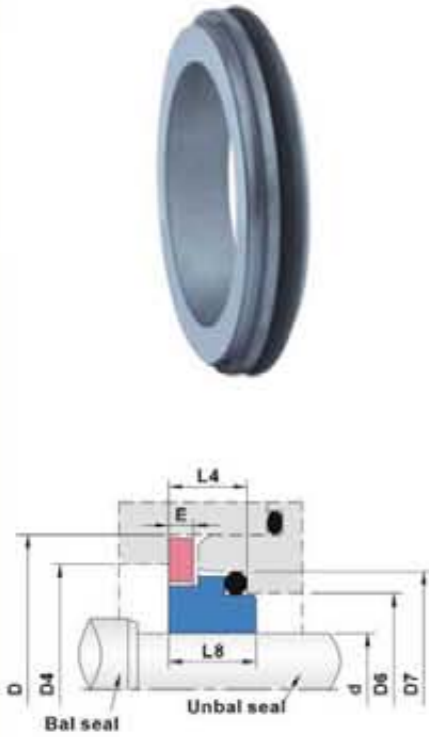

规格/Size (公制/Metric)	d	D		D4		D6	D7	L4	L8	E
		Undal Seal	Bal Seal	Undal Seal	Bal Seal					
14	14	30	38	26	34	21	25	12.0	12.8	4
16	16	32	40	28	36	23	27	12.0	12.8	4
18	18	38	42	34	38	27	33	13.5	14.5	4
20	20	40	43	36	40	29	35	13.5	14.5	4
22	22	42	46	38	42	31	37	13.5	14.5	4
24	24	43	48	40	44	33	39	13.3	14.3	4
25	25	46	50	41	46	34	40	13.0	14.0	4
28	28	48	53	44	49	37	43	12.5	13.5	4
30	30	50	60	46	51	39	45	12.0	13.0	4
32	32	53	62	48	58	42	48	12.0	13.0	4
33	33	53	62	49	58	42	48	12.0	13.0	4
35	35	60	65	51	60	44	50	12.0	13.0	4
38	38	62	67	58	63	49	56	13.0	14.0	6
40	40	65	70	60	65	51	58	13.0	14.0	6
43	43	67	72	63	68	54	61	13.0	14.0	6
45	45	70	75	65	70	56	63	13.0	14.0	6
48	48	72	77	68	73	59	66	13.0	14.0	6
50	50	75	86	70	75	62	70	13.5	14.5	6
53	53	77	88	73	83	65	73	13.5	14.5	6
55	55	86	91	75	85	67	75	13.5	14.5	6
58	58	88	93	83	88	70	78	13.5	14.2	6
60	60	91	96	88	90	72	80	13.5	14.2	6
65	65	96	103	90	95	77	85	13.5	14.2	6
68	68	98	-	93	-	81	90	13.5	14.2	6
70	70	103	108	95	104	83	92	14.5	15.2	6
75	75	108	120	104	109	88	97	14.5	15.2	6
80	80	120	125	109	114	95	105	15.0	15.7	6
85	85	125	130	114	119	100	110	15.0	15.7	6
90	90	130	135	119	124	105	115	15.0	15.7	6
95	95	135	140	124	129	110	120	15.0	15.7	6
100	100	140	145	129	134	115	125	15.0	15.7	6

TBG9 / G92



规格/Size (公制/Metric)	d	D6	D7	D8	L4	L8
10	10	17	21	3	10.0	17.5
12	12	19	23	3	10.0	17.5
14	14	21	25	3	10.0	17.5
16	16	23	27	3	10.0	17.5
18	18	27	33	3	11.5	19.5
20	20	29	35	3	11.5	19.5
22	22	31	37	3	11.5	19.5
24	24	33	39	3	11.5	19.5
25	25	34	40	3	11.5	19.5
28	28	37	43	3	11.5	19.5
30	30	39	45	3	11.5	19.5
32	32	42	48	3	11.5	19.5
33	33	42	48	3	11.5	19.5
35	35	44	50	3	11.5	19.5
38	38	49	56	4	14.0	22.0
40	40	51	58	4	14.0	22.0
43	43	54	61	4	14.0	22.0
45	45	56	63	4	14.0	22.0
48	48	59	68	4	14.0	22.0
50	50	62	70	4	15.0	23.0
53	53	65	73	4	15.0	23.0
55	55	67	75	4	15.0	23.0
58	58	70	78	4	15.0	23.0
60	60	72	80	4	15.0	23.0
63	63	75	83	4	15.0	23.0
65	65	77	85	4	15.0	23.0
68	68	81	90	4	18.0	26.0
70	70	83	92	4	18.0	26.0
75	75	88	97	4	18.0	26.0
80	80	95	105	4	18.2	26.2
85	85	100	110	4	18.2	26.2
90	90	105	115	4	18.2	26.2
95	95	110	120	4	17.2	25.2
100	100	115	125	4	17.2	25.2

TBG16

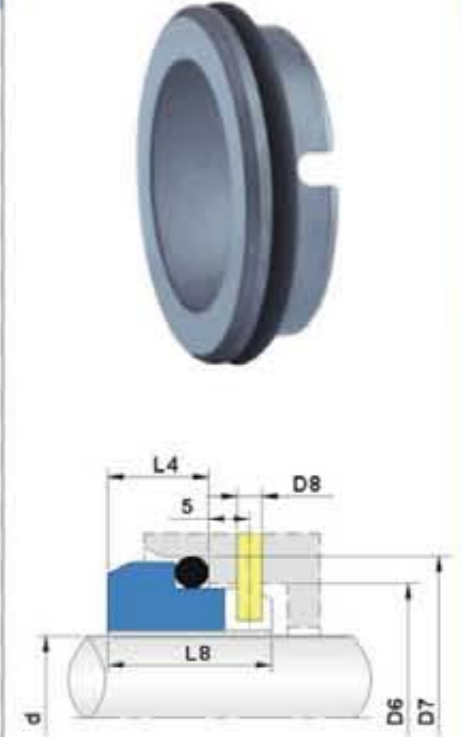

规格/Size (公制/Metric)	d	D6	D7	D8	L4	L8
18	18	27	33	3	7.0	15.0
20	20	29	35	3	7.0	15.0
22	22	31	37	3	7.0	15.0
24	24	33	39	3	7.0	15.0
25	25	34	40	3	7.0	15.0
28	28	37	43	3	7.0	15.0
30	30	39	45	3	7.0	15.0
32	32	42	48	3	7.0	15.0
33	33	42	48	3	7.0	15.0
35	35	44	50	3	7.0	15.0
38	38	49	56	4	8.0	16.0
40	40	51	58	4	8.0	16.0
43	43	54	61	4	8.0	16.0
45	45	56	63	4	8.0	16.0
48	48	59	66	4	8.0	16.0
50	50	62	70	4	9.5	17.0
53	53	65	73	4	9.5	17.0
55	55	67	75	4	9.5	17.0
58	58	70	78	4	10.5	18.0
60	60	72	80	4	10.5	18.0
63	63	75	83	4	10.5	18.0
65	65	77	85	4	10.5	18.0
68	68	81	90	4	11.0	18.5
70	70	83	92	4	11.5	19.0
75	75	88	97	4	11.5	19.0
80	80	95	105	4	11.5	19.0
85	85	100	110	4	11.5	19.0
90	90	105	115	4	13.0	20.5
95	95	110	120	4	13.0	20.5
100	100	115	125	4	13.0	20.5

TBG46

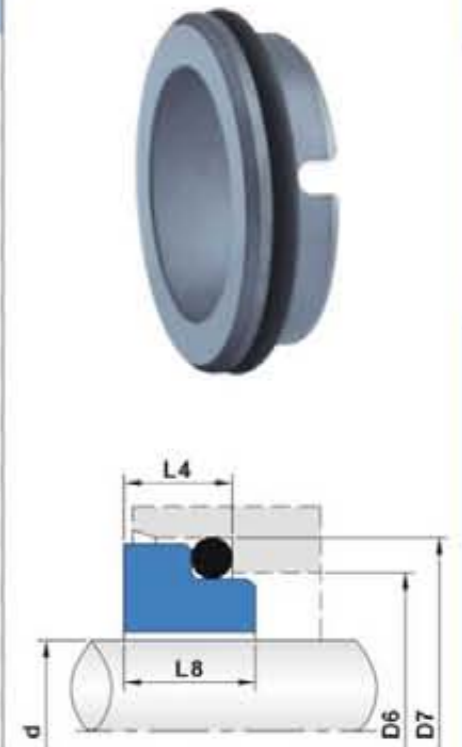

规格/Size (公制/Metric)	d	D6	D7	D8	L4	L8
18	18	27	33	3	9.0	17.0
20	20	29	35	3	9.0	17.0
22	22	31	37	3	9.0	17.0
24	24	33	39	3	9.0	17.0
25	25	34	40	3	9.0	17.0
28	28	37	43	3	9.5	17.5
30	30	39	45	3	9.5	17.5
32	32	42	48	3	9.5	17.5
33	33	42	48	3	9.5	17.5
35	35	44	50	3	9.5	17.5
38	38	49	56	4	10.5	18.5
40	40	51	58	4	10.5	18.5
43	43	54	61	4	10.5	18.5
45	45	56	63	4	10.5	18.5
48	48	59	66	4	10.5	18.5
50	50	62	70	4	12.0	19.5
53	53	65	73	4	12.0	19.5
55	55	67	75	4	12.0	19.5
58	58	70	78	4	13.0	20.5
60	60	72	80	4	13.0	20.5
63	63	75	83	4	13.0	20.5
65	65	77	85	4	13.0	20.5
68	68	81	90	4	13.5	21.0
70	70	83	92	4	14.0	21.5
75	75	88	97	4	14.0	21.5
80	80	95	105	4	14.0	21.5
85	85	100	110	4	14.0	21.5
90	90	105	115	4	15.5	23.0
95	95	110	120	4	15.5	23.0
100	100	115	125	4	15.5	23.0



TB24DINL

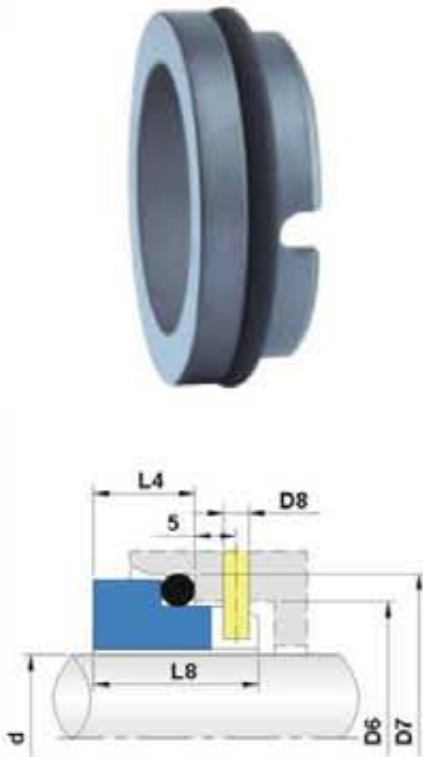

规格/Size (公制/Metric)	d	D6	D7	D8	L4	L8
10	10	17	21	3	8.6	15.0
12	12	19	23	3	8.6	15.0
14	14	21	25	3	8.6	15.0
16	16	23	27	3	8.6	15.0
18	18	27	33	3	10.0	17.0
20	20	29	35	3	10.0	17.0
22	22	31	37	3	10.0	17.0
24	24	33	39	3	10.0	17.0
25	25	34	40	3	10.0	17.0
28	28	37	43	3	10.0	17.0
30	30	39	45	3	10.0	17.0
32	32	42	48	3	10.0	17.0
33	33	42	48	3	10.0	17.0
35	35	44	50	3	10.0	17.0
38	38	49	56	4	11.0	18.0
40	40	51	58	4	11.0	18.0
43	43	54	61	4	11.0	18.0
45	45	56	63	4	11.0	18.0
48	48	59	66	4	11.0	18.0
50	50	62	70	4	13.0	20.0
53	53	65	73	4	13.0	20.0
55	55	67	75	4	13.0	20.0
58	58	70	78	4	13.0	20.0
60	60	72	80	4	13.0	20.0
63	63	75	83	4	13.0	20.0
65	65	77	85	4	13.0	20.0
68	68	81	90	4	15.3	22.0
70	70	83	92	4	15.3	22.0
75	75	88	97	4	15.3	22.0
80	80	95	105	4	15.7	22.5
85	85	100	110	4	15.7	22.5
90	90	105	115	4	15.7	22.5
95	95	110	120	4	15.7	22.5
100	100	115	125	4	15.7	22.5

TBBD

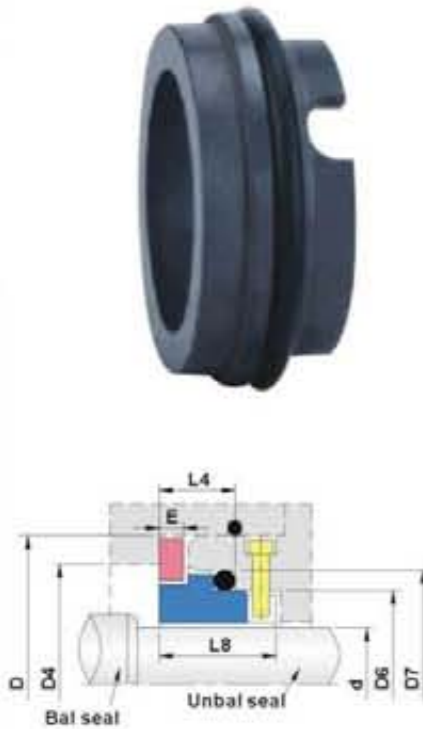

规格/Size (公制/Metric)	d	D		D4		D6	D7	L4	L8	E
		Undal Seal	Bal. Seal	Undal Seal	Bal. Seal					
14	14	30	38	26	34	21	25	12.0	18.5	4
16	16	32	40	28	36	23	27	12.0	18.5	4
18	18	38	42	34	38	27	33	13.5	20.5	4
20	20	40	43	36	40	29	35	13.5	20.5	4
22	22	42	46	38	42	31	37	13.5	20.5	4
24	24	43	48	40	44	33	39	13.3	20.3	4
25	25	46	50	41	46	34	40	13.0	20.0	4
28	28	48	53	44	49	37	43	12.5	19.5	4
30	30	50	60	46	51	39	45	12.0	19.0	4
32	32	53	62	48	58	42	48	12.0	19.0	4
33	33	53	62	49	58	42	48	12.0	19.0	4
35	35	60	65	51	60	44	50	12.0	19.0	4
38	38	62	67	58	63	49	56	13.0	20.0	6
40	40	65	70	60	65	51	58	13.0	20.0	6
43	43	67	72	63	68	54	61	13.0	20.0	6
45	45	70	75	65	70	56	63	13.0	20.0	6
48	48	72	77	68	73	59	66	13.0	20.5	6
50	50	75	86	70	75	62	70	13.5	20.5	6
53	53	77	88	73	83	65	73	13.5	20.5	6
55	55	86	91	75	85	67	75	13.5	20.5	6
58	58	88	93	83	88	70	78	13.5	20.5	6
60	60	91	96	88	90	72	80	13.5	20.5	6
65	65	96	103	90	95	77	85	13.5	20.5	6
68	68	98	-	93	-	81	90	13.5	20.5	6
70	70	103	108	95	104	83	92	14.5	21.5	6
75	75	108	120	104	109	88	97	14.5	21.5	6
80	80	120	125	109	114	95	105	15.0	22.0	6
85	85	125	130	114	119	100	110	15.0	22.0	6
90	90	130	135	119	124	105	115	15.0	22.0	6
95	95	135	140	124	129	110	120	15.0	22.0	6
100	100	140	145	129	134	115	125	15.0	22.0	6

TBN

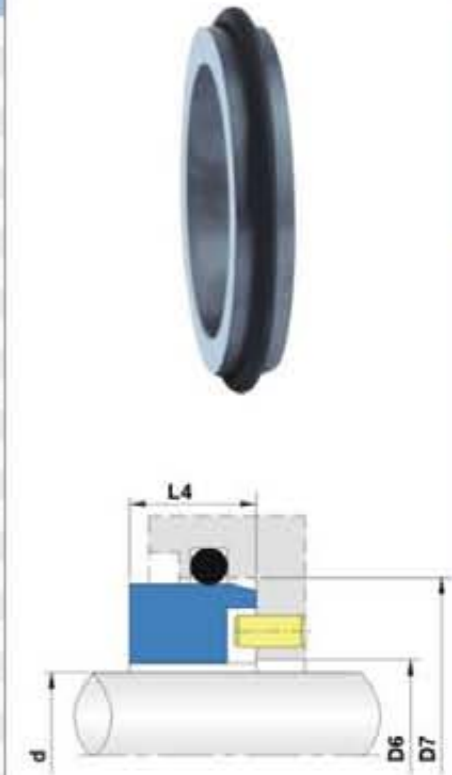

规格/Size (英寸/Inch)	d	D6	D7	L4
0.500	12.7	14.0	25.60	7.92
0.625	15.8	17.5	31.95	10.31
0.750	19.0	21.0	35.12	10.31
0.875	22.2	24.0	38.30	10.31
1.000	25.4	27.5	41.48	11.10
1.125	28.5	30.5	44.65	11.10
1.250	31.7	33.5	47.83	11.10
1.375	34.9	37.0	51.00	11.10
1.500	38.1	40.0	54.18	11.10
1.625	41.2	43.5	60.53	12.70
1.750	44.4	46.5	63.70	12.70
1.875	47.6	49.5	66.88	12.70
2.000	50.8	53.0	70.05	12.70
2.125	53.9	56.0	76.40	14.27
2.250	57.1	59.0	79.58	14.27
2.375	60.3	62.5	82.75	14.27
2.500	63.5	65.5	85.93	14.27
2.625	66.6	68.5	85.93	15.88
2.750	69.8	72.0	89.10	15.88
2.875	73.0	75.0	95.45	15.88
3.000	76.2	78.5	98.63	15.88
3.125	79.3	81.5	101.80	19.84
3.250	82.5	84.5	104.98	19.84
3.375	85.7	88.0	108.15	19.84
3.500	88.9	91.0	111.33	19.84
3.625	92.0	94.0	114.50	19.84
3.750	95.2	97.5	117.68	19.84
3.875	98.4	100.5	120.85	19.84
4.000	101.6	103.5	124.03	19.84

TBT20

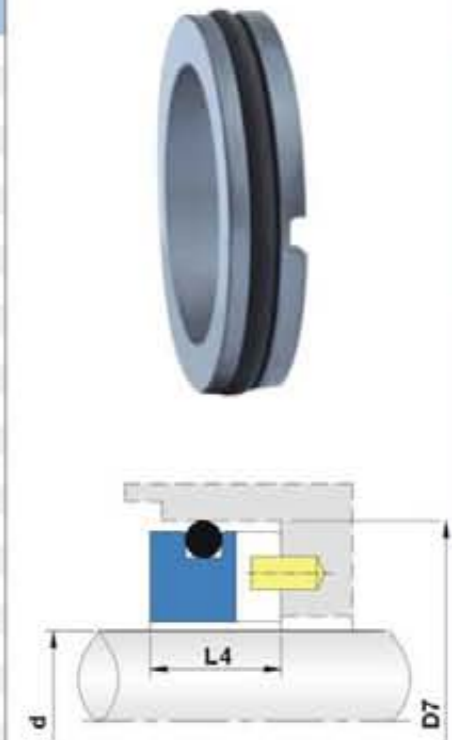

规格/Size (英寸/Inch)	规格/Size (公制/Metric)	D7	L4	规格/Size (英寸/Inch)	规格/Size (公制/Metric)	D7	L4
0.375	-	24.60	8.70	1.625	-	60.35	11.90
-	10.00	24.60	8.70	-	42.00	63.50	11.90
-	12.00	27.79	8.70	-	43.00	63.50	11.90
0.500	-	27.79	8.70	1.750	-	63.50	11.90
-	13.00	27.79	8.70	-	45.00	63.50	11.90
-	14.00	30.95	10.30	1.875	-	66.70	11.90
-	15.00	30.95	10.30	-	48.00	66.70	11.90
0.625	-	30.95	10.30	-	50.00	69.85	13.50
-	16.00	30.95	10.30	2.000	-	69.85	13.50
-	18.00	34.15	10.30	-	53.00	73.05	13.50
0.750	-	34.15	10.30	2.125	-	0.05	13.50
-	20.00	35.70	10.30	-	55.00	76.20	13.50
-	22.00	37.30	10.30	2.250	-	76.20	13.50
0.875	-	37.30	10.30	-	58.00	79.40	13.50
-	24.00	40.50	10.30	-	60.00	79.40	13.50
-	25.00	40.50	10.30	2.375	-	79.40	13.50
1.000	-	40.50	10.30	-	63.00	82.55	13.50
-	28.00	47.63	11.90	2.500	-	82.55	13.50
1.125	-	47.63	11.90	-	65.00	92.10	15.90
-	30.00	50.80	11.90	2.625	-	92.10	15.90
1.250	-	50.80	11.90	2.750	-	95.25	15.90
-	32.00	50.80	11.90	-	70.00	95.25	15.90
-	33.00	53.98	11.90	2.875	-	98.45	15.90
1.375	-	53.98	11.90	-	75	101.65	15.90
-	35	53.98	11.90	3.000	-	101.65	15.90
-	38	57.15	11.90	-	80	111.15	19.90
1.500	-	57.15	11.90	-	90	120.65	19.90
-	40	60.35	11.90	-	100	133.35	19.90



TBT21

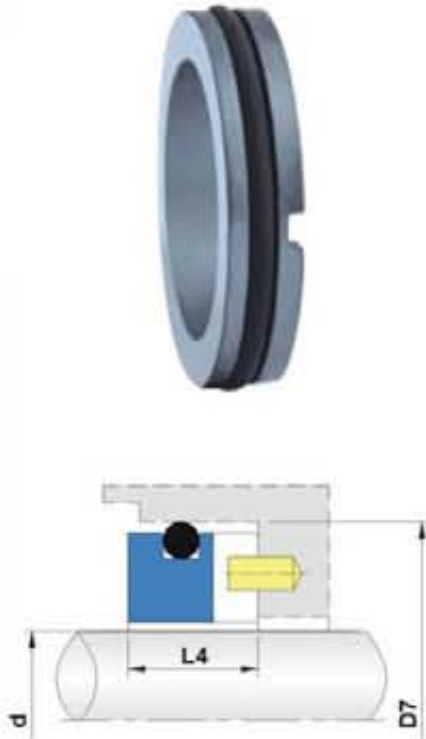

规格/Size (英寸/Inch)	规格/Size (公制/Metric)	D7	L4	规格/Size (英寸/Inch)	规格/Size (公制/Metric)	D7	L4
0.375	-	22.22	7.95	1.625	-	60.33	12.70
-	10	22.22	7.95	-	42	63.50	12.70
-	12	25.40	7.95	-	43	63.50	12.70
0.500	-	25.40	7.95	1.750	-	63.50	12.70
-	13	25.40	7.95	-	45	66.68	12.70
-	14	31.75	10.30	1.875	-	66.68	12.70
-	15	31.75	10.30	-	48	69.85	12.70
0.625	-	31.75	10.30	-	50	69.85	12.70
-	16	31.75	10.30	2.000	-	69.85	12.70
-	18	34.93	10.30	-	53	76.20	14.30
0.750	-	34.93	10.30	2.125	-	76.20	14.30
-	20	38.10	10.30	-	55	79.38	14.30
-	22	38.10	10.30	2.250	-	79.30	14.30
0.875	-	38.10	10.30	-	58	82.55	14.30
-	24	41.28	11.10	-	60	82.55	14.30
-	25	41.28	11.10	2.375	-	82.55	14.30
1.000	-	41.28	11.10	-	63	85.73	14.30
-	28	44.44	11.10	2.500	-	85.73	14.30
1.125	-	44.44	11.10	-	65	85.73	15.90
-	30	47.63	11.10	2.625	-	85.73	15.90
1.250	-	47.63	11.10	2.750	-	88.90	15.90
-	32	47.63	11.10	-	70	88.90	15.90
-	33	50.80	11.10	2.875	-	95.25	15.90
1.375	-	50.8	11.10	-	75	98.43	15.90
-	35	50.8	11.10	3.000	-	98.43	15.90
-	38	53.98	11.10	-	80	101.60	19.88
1.500	-	53.98	11.10	-	90	111.13	19.88
-	40	60.35	12.70	-	100	123.83	19.88

TBCG60



规格/Size (公制/Metric)	d	D6	D7	L4
10	10	17	21	6.6
12	12	19	23	6.6
14	14	21	25	6.6
16	16	23	27	6.6
18	18	27	33	7.5
20	20	29	35	7.5
22	22	31	37	7.5
24	24	33	39	7.5
25	25	34	40	7.5
28	28	37	43	7.5
30	30	39	45	7.5
32	32	42	48	7.5
33	33	42	48	7.5
35	35	44	50	7.5
38	38	49	56	9.0
40	40	51	58	9.0
43	43	54	61	9.0
45	45	56	63	9.0
48	48	59	66	9.0
50	50	62	70	11.0
53	53	65	73	11.0
55	55	67	75	11.0
58	58	70	78	11.0
60	60	72	80	11.0
63	63	75	83	11.0
65	65	77	85	11.0
68	68	81	90	11.0
70	70	83	92	11.0
75	75	88	97	11.0
80	80	95	105	12.0
85	85	100	110	14.0
90	90	105	115	14.0
95	95	110	120	14.0
100	100	115	125	14.0

TBCT20



规格/Size (公制/Metric)	d	D6	D7	L4
10	10	11.0	24.60	9.0
12	12	13.5	27.80	9.0
14	14	17.0	30.95	10.5
15	15	17.0	30.95	10.5
16	16	17.0	30.95	10.5
18	18	20.0	34.15	10.5
19	19	20.0	34.15	10.5
20	20	21.5	35.70	10.5
22	22	23.0	37.30	10.5
24	24	26.5	40.50	10.5
25	25	26.5	40.50	10.5
28	28	29.5	47.65	12.0
30	30	32.5	50.80	12.0
32	32	32.5	50.80	12.0
33	33	36.5	54.00	12.0
35	35	36.5	54.00	12.0
38	38	39.5	57.15	12.0
40	40	42.5	60.35	12.0
42	42	46.0	63.50	12.0
43	43	46.0	63.50	12.0
45	45	46.0	63.50	12.0
48	48	49.0	66.70	12.0
50	50	52.0	69.85	13.5
53	53	55.5	73.05	13.5
55	55	58.5	76.20	13.5
58	58	61.5	79.40	13.5
60	60	61.5	79.40	13.5
65	65	68.0	92.10	16.0
68	68	71.0	95.25	16.0
70	70	71.0	95.25	16.0
75	75	77.5	101.60	16.0
80	80	84.0	114.30	20.0
85	85	87.0	117.50	20.0
90	90	93.5	123.85	20.0
95	95	96.5	127.00	20.0
100	100	103.0	133.35	20.0

TBCT20-1



规格/Size (英寸/Inch)	d	D7	L4
0.375	9.5	24.8	8.7
0.500	12.7	27.8	8.7
0.625	15.8	30.95	10.3
0.750	19.0	34.15	10.3
0.813	20.6	35.70	10.3
0.875	22.2	37.30	10.3
1.000	25.4	40.50	10.3
1.125	28.5	47.65	11.9
1.250	31.7	50.80	11.9
1.375	34.9	54.00	11.9
1.500	38.1	57.15	11.9
1.625	41.2	60.35	11.9
1.750	44.4	63.50	11.9
1.875	47.6	66.70	11.9
2.000	50.8	69.85	13.5
2.125	53.9	73.05	13.5
2.250	57.1	76.20	13.5
2.375	60.3	79.40	13.5
2.500	63.5	82.55	13.5
2.625	66.6	82.05	15.9
2.750	69.8	95.25	15.9
2.875	73.0	98.45	15.9
3.000	76.2	101.65	15.9
3.125	79.3	111.15	20.0
3.250	82.5	114.30	20.0
3.375	85.7	117.50	20.0
3.500	88.9	120.65	20.0
3.625	92.0	123.85	20.0
3.750	95.2	127.00	20.0
3.875	98.4	130.20	20.0
4.000	101.6	133.35	20.0



TBCT24



规格/Size (公制/Metric)	d	D6	D7	L4
10	10	17	21	8.6
12	12	19	23	8.6
14	14	21	25	8.6
16	16	23	27	10.0
18	18	27	33	10.0
20	20	29	35	10.0
22	22	31	37	10.0
24	24	33	39	10.0
25	25	34	40	10.0
28	28	37	43	10.0
30	30	39	45	10.0
32	32	42	48	10.0
33	33	42	48	10.0
35	35	44	50	10.0
38	38	49	56	11.0
40	40	51	58	11.0
43	43	54	61	11.0
45	45	56	63	11.0
48	48	59	66	11.0
50	50	62	70	13.0
53	53	65	73	13.0
55	55	67	75	13.0
58	58	70	78	13.0
60	60	72	80	13.0
63	63	75	83	13.0
65	65	77	85	13.0
68	68	81	90	13.0
70	70	83	92	15.3
75	75	88	97	15.3
80	80	95	105	15.3
85	85	100	110	15.7
90	90	105	115	15.7
95	95	110	120	15.7
100	100	115	125	15.7

TBT11

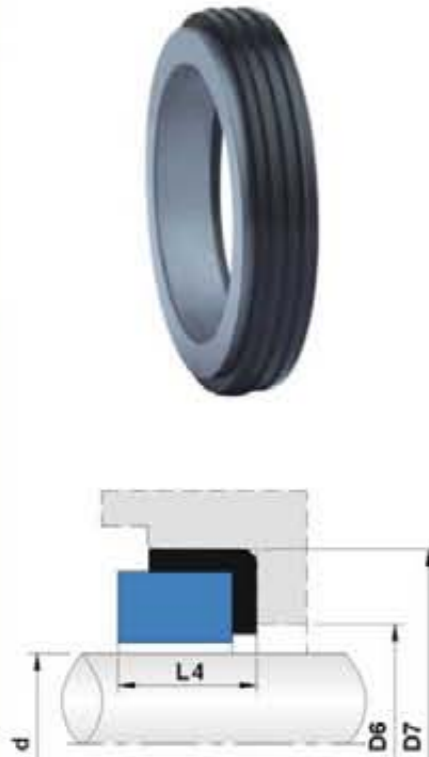

规格/Size (英寸/Inch)	d	D6	D7	L4
0.375	9.5	15.88	22.23	7.95
0.500	12.7	19.05	25.40	7.95
0.625	15.8	23.80	31.75	10.31
0.750	19.0	26.97	34.93	10.31
0.875	22.2	30.15	38.10	10.31
1.000	25.4	33.32	41.28	11.10
1.125	28.5	36.50	44.45	11.10
1.250	31.7	39.70	47.63	11.10
1.375	34.9	42.85	50.80	11.10
1.500	38.1	46.05	53.98	11.10
1.625	41.2	50.80	60.33	12.70
1.750	44.4	53.97	63.50	12.70
1.875	47.6	57.15	66.67	12.70
2.000	50.8	60.33	69.85	12.70
2.125	53.9	63.50	73.02	14.27
2.250	57.1	66.67	76.20	14.27
2.375	60.3	69.85	79.38	14.27
2.500	63.5	73.02	82.55	14.27
2.625	66.6	76.20	85.73	15.88
2.750	69.8	79.38	88.90	15.88
2.875	73.0	82.55	92.08	15.88
3.000	76.2	85.73	95.25	15.88
3.125	79.3	88.90	98.43	15.88
3.250	82.5	92.08	101.60	19.84
3.375	85.7	95.25	104.78	19.84
3.500	88.9	98.43	107.95	19.84
3.625	92.0	101.60	111.13	19.84
3.750	95.2	104.78	114.30	19.84
3.875	98.4	107.95	117.48	19.84
4.000	101.6	111.13	120.65	19.84

TBL210



规格/Size (公制/Metric)	d	D6	D7	L4
10	10	15	21	5
12	12	17	23	5
14	14	19	25	5
15	15	20	26	5
16	16	23	27	5
18	18	25	33	5
20	20	27	35	5
22	22	29	37	5
24	24	31	39	5
25	25	32	40	5
28	28	35	43	5
30	30	37	45	7
32	32	40	48	7
33	33	40	48	7
35	35	42	50	8
38	38	47	56	8
40	40	49	58	8
43	43	52	61	8
45	45	54	63	8
48	48	57	66	10
50	50	60	70	10
53	53	63	73	10
55	55	65	75	10
58	58	68	78	10
60	60	70	80	12
63	63	73	83	12
65	65	75	85	12
68	68	79	90	12
70	70	81	92	12
75	75	88	97	12
80	80	92	105	12.5
85	85	97	110	12.5
90	90	102	115	12.5
95	95	117	120	12.5
100	100	122	125	12.5

TBBP

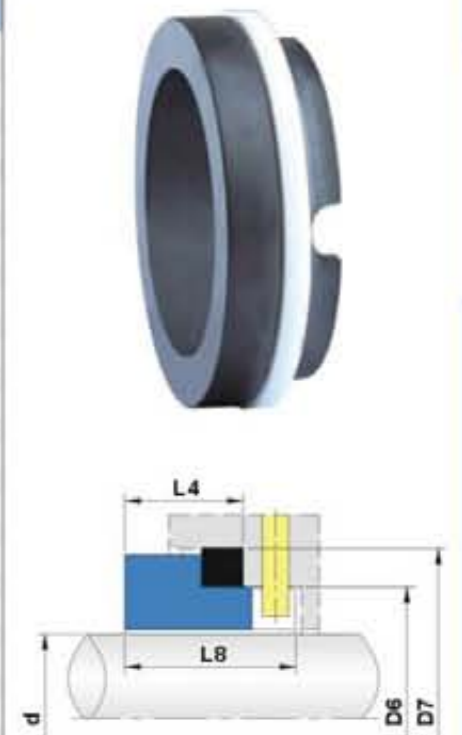

规格/Size (公制/Metric)	d	D6	D7	L4	L8
14	14	21	25	12.0	18.5
16	16	23	27	12.0	18.5
18	18	27	33	13.5	20.5
20	20	29	35	13.5	20.5
22	22	31	37	13.5	20.5
24	24	33	39	13.3	20.3
25	25	34	40	13.0	20.0
28	28	37	43	12.5	19.5
30	30	39	45	12.0	19.0
32	32	42	48	12.0	19.0
33	33	42	48	12.0	19.0
35	35	44	50	12.0	19.0
38	38	49	56	13.0	20.0
40	40	51	58	13.0	20.0
43	43	54	61	13.0	20.0
45	45	56	63	13.0	20.0
48	48	59	66	13.0	20.0
50	50	62	70	13.5	20.5
53	53	65	73	13.5	20.5
55	55	67	75	13.5	20.5
58	58	70	78	13.5	20.5
60	60	72	80	13.5	20.5
63	63	75	83	13.5	20.5
65	65	77	85	13.5	20.5
68	68	81	90	13.5	20.5
70	70	83	92	14.5	21.5
75	75	88	97	14.5	21.5
80	80	95	105	15.0	22.0
85	85	100	110	15.0	22.0
90	90	105	115	15.0	22.0
95	95	110	120	15.0	22.0
100	100	115	125	15.0	22.0



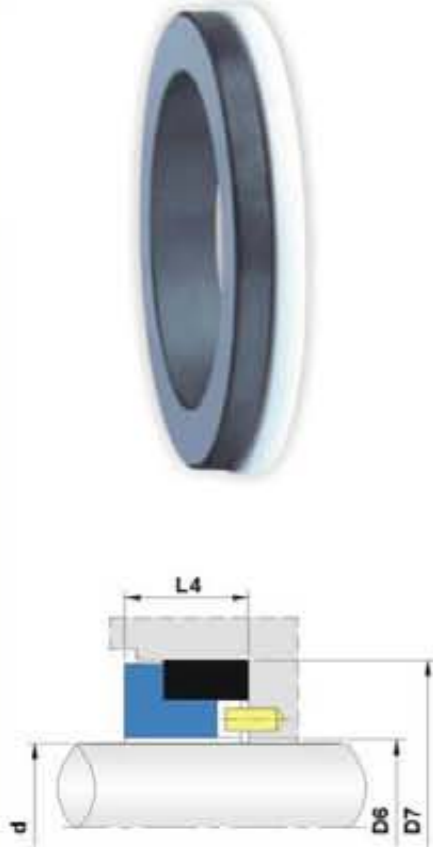

规格/Size (英寸/inch)	d	D6	D7	L4
0.250	6.3	7.1	19.05	7.9
0.375	9.5	10.2	22.23	7.9
0.500	12.7	13.4	25.40	7.9
0.625	15.8	16.6	31.75	10.3
0.750	19.0	19.7	34.93	10.3
0.875	22.2	22.9	38.10	10.3
1.000	25.4	26.1	41.28	11.1
1.125	28.5	29.3	44.45	11.1
1.250	31.7	32.4	48.63	11.1
1.375	34.9	35.6	50.80	11.1
1.500	38.1	38.8	53.98	11.1
1.625	41.2	42.4	60.33	12.7
1.750	44.4	45.5	63.50	12.7
1.875	47.6	48.7	66.68	12.7
2.000	50.8	51.9	69.85	12.7
2.125	53.9	55.0	76.20	14.3
2.250	57.1	58.2	79.38	14.3
2.375	60.3	61.4	82.55	14.3
2.500	63.5	64.6	85.73	14.3
2.625	66.6	67.7	85.73	15.9
2.750	69.8	70.9	88.90	15.9
2.875	73.0	74.1	95.25	15.9
3.000	76.2	77.3	98.43	15.9
3.125	79.3	80.5	101.60	19.8
3.250	82.5	83.6	104.78	19.8
3.375	85.7	86.8	107.95	19.8
3.500	88.9	90.0	111.13	19.8
3.625	92.0	93.1	114.30	19.8
3.750	95.2	96.3	117.48	19.8
3.875	98.4	99.5	120.65	19.8
4.000	101.6	102.7	123.83	19.8
4.125	104.7	106.3	130.18	19.8
4.250	107.9	109.5	133.35	19.8
4.375	111.1	112.7	136.53	19.8
4.500	114.3	115.9	139.70	19.8
4.625	117.4	119.0	142.88	19.8
4.750	120.6	122.2	146.05	19.8
4.875	123.8	125.4	149.23	19.8
5.000	127.0	128.6	152.40	19.8



规格/Size Inch d	Size Code	Metric Size d	D1	D6	L1	L2	Gasket thick
0.500	0127		13.70	29.05	17.40	7.90	0.8
0.625	0158		16.80	33.04	17.40	7.90	0.8
0.750	0191		20.00	36.21	17.40	7.90	0.8
	0200	20	21.00	36.90	17.40	7.90	0.8
0.875	0222		23.20	39.90	17.40	7.90	0.8
	0250	25	26.00	41.90	17.40	7.90	0.8
1.000	0254		26.40	42.56	17.40	7.90	0.8
1.125	0286		29.60	45.74	26.90	11.10	1.6
	0300	30	31.00	48.69	26.90	11.10	1.6
1.250	0317		32.70	50.50	26.90	11.10	1.6
1.375	0349		36.00	53.68	26.90	11.10	1.6
1.500	0381		39.10	56.85	26.90	11.10	1.6
1.625	0412		42.20	63.20	26.90	11.10	1.6
1.750	0444		45.40	66.38	26.90	11.10	1.6
1.875	0467		49.00	69.55	26.90	11.10	1.6
	0500	50	51.00	71.90	26.90	11.10	1.6
2.000	0508		51.80	72.73	26.90	11.10	1.6
2.125	0539		54.90	79.08	33.30	14.30	1.6
2.250	0571		58.10	82.25	33.30	14.30	1.6
2.375	0603		61.30	85.43	33.30	14.30	1.6
2.500	0635		64.50	88.60	33.30	14.30	1.6
2.625	0666		67.60	91.78	33.30	14.30	1.6
2.750	0698		71.00	94.90	33.30	14.30	1.6
2.875	0730		74.00	98.13	33.30	14.30	1.6
3.000	0762		77.20	99.71	33.30	14.30	1.6
3.125	0794		80.40	102.89	33.30	14.30	1.6
3.500	0889		89.90	114.00	34.30	14.30	1.6
3.750	0953		96.30	120.35	34.30	14.30	1.6
4.000	1016		102.60	126.70	34.30	14.30	1.6
4.125	1050	105	106.00	139.90	36.00	16.00	1.6
4.500	1143		115.30	139.40	34.30	14.30	1.6
5.000	1397		140.70	177.50	36.00	16.00	1.6

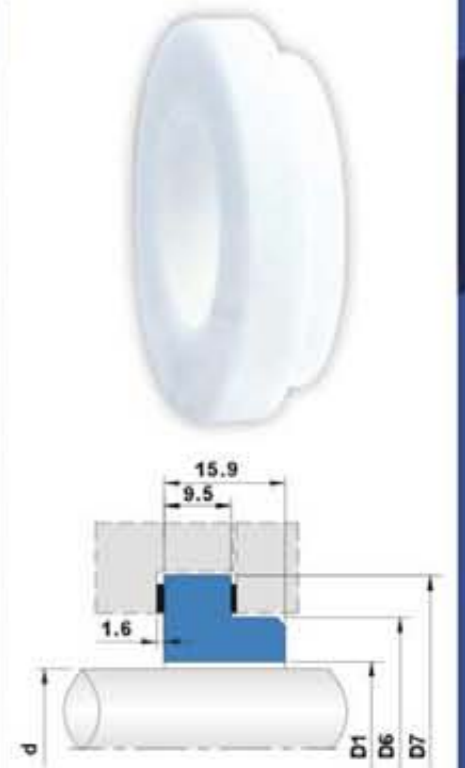

规格/Size (英寸/inch)	D1	D6	D7
0.750	21.60	34.80	44.45
0.875	24.75	37.95	47.65
1.000	27.95	41.15	50.80
1.125	31.10	44.30	53.95
1.187	32.70	45.90	55.55
1.250	34.30	47.50	57.15
1.375	37.45	50.65	60.30
1.500	40.65	57.00	66.65
1.625	43.80	60.15	69.85
1.750	47.00	63.35	76.20
1.875	50.15	66.50	79.35
2.000	53.35	69.70	82.55
2.125	56.50	72.85	88.90
2.250	59.70	76.05	92.05
2.375	62.85	79.20	95.25
2.500	66.00	82.40	101.50
2.625	69.20	85.60	104.75
3.000	78.00	93.50	121.00



TB17D

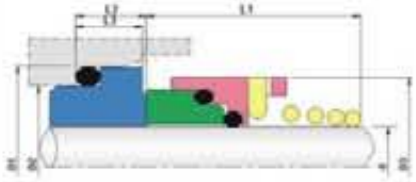

STOCK MATERIALS AND FACE MATERIAL CODE

Rotary Face	Stationary Face
SIC	CAR
SIC	SIC

Elastomers: VIT, EPDM, NBR

规格/Size (公制/Metric)	D1	D2	D3	L1	L2	L3
10	21.00	17.00	19.00	15.00	7.00	4.00
12	23.00	19.00	21.00	18.00	7.00	4.00
14	25.00	21.00	23.00	22.00	7.00	4.00
16	27.00	23.00	26.00	23.00	7.00	4.00
18	33.00	27.00	29.00	24.00	10.00	5.00
20	35.00	29.00	31.00	25.00	10.00	5.00
22	37.00	31.00	33.00	25.00	10.00	5.00
24	39.00	33.00	35.00	27.00	10.00	5.00
25	40.00	34.00	36.00	27.00	10.00	5.00
28	43.00	37.00	40.00	29.00	10.00	5.00
30	45.00	39.00	43.00	30.00	10.00	5.00
32	48.00	42.00	46.00	30.00	10.00	5.00
33	48.00	42.00	46.00	39.00	10.00	5.00
35	50.00	44.00	49.00	39.00	10.00	5.00
38	56.00	49.00	53.00	42.00	13.00	6.00
40	58.00	51.00	56.00	42.00	13.00	6.00
43	61.00	54.00	59.00	47.00	13.00	6.00
45	63.00	56.00	61.00	47.00	13.00	6.00
48	66.00	59.00	64.00	47.00	13.00	6.00
50	70.00	62.00	66.00	46.00	14.00	6.00
53	73.00	65.00	69.00	56.00	14.00	6.00
55	75.00	67.00	71.00	56.00	14.00	6.00
58	78.00	70.00	76.00	56.00	14.00	6.00
60	80.00	72.00	78.00	56.00	14.00	6.00
63	83.00	75.00	81.00	56.00	14.00	6.00
65	85.00	77.00	84.00	66.00	14.00	6.00
68	90.00	81.00	88.00	64.00	16.00	7.00
70	92.00	83.00	89.60	64.00	16.00	7.00
75	97.00	88.00	98.00	64.00	16.00	7.00
80	105.00	95.00	100.00	72.00	18.00	7.00
85	110.00	100.00	107.00	72.00	18.00	7.00
90	115.00	105.00	111.00	72.00	18.00	7.00
95	120.00	110.00	119.00	72.00	18.00	7.00
100	125.00	115.00	123.80	72.00	18.00	7.00

TB41

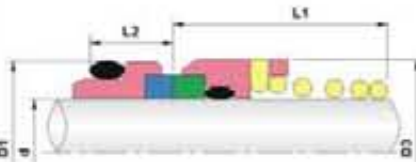

STOCK MATERIALS AND FACE MATERIAL CODE

Rotary Face	Stationary Face
CAR	SIC
SIC	SIC

Elastomers: VIT, EPDM, NBR

规格/Size (公制/Metric)	D3	D1	L2	L1
8	16.0	17.1	5.5	15.2
10	17.5	18.1	5.5	15.2
12	20.0	20.6	5.5	18.2
14	23.0	23.1	6.0	22.2
15	24.0	26.9	7.0	22.2
16	26.0	26.9	7.0	23.2
17	27.0	26.9	7.0	23.2
18	29.0	30.9	8.0	24.2
19	30.0	30.9	8.0	25.2
20	30.0	30.9	8.0	25.2
22	34.0	35.4	8.0	25.2
24	35.0	35.4	8.0	27.2
25	37.0	38.2	8.5	27.2
26	38.0	38.2	8.5	27.2
28	42.0	43.3	9.0	29.2
30	43.0	43.3	9.0	30.2
32	45.0	43.3	9.0	30.2
33	48.0	53.5	11.5	39.2
35	50.0	53.5	11.5	39.2
38	54.0	60.5	11.5	39.2
40	56.0	60.5	11.5	39.2
42	59.0	60.5	11.5	39.2
43	60.0	60.5	11.5	39.2
45	64.0	65.5	11.5	41.2
48	68.0	65.5	11.5	41.2
50	69.0	72.5	11.5	45.2
55	74.0	72.5	11.5	47.2
60	80.0	79.3	11.5	49.2
65	87.0	84.5	11.5	51.2
70	92.0	89.5	11.5	51.2
75	97.0	94.5	11.5	57.2
80	102.0	99.5	11.5	59.2
85	110.0	105.5	13.5	59.2
90	117.0	111.5	13.5	62.2
95	122.0	116.5	13.5	62.2
100	127.0	119.5	13.5	75.2

TB80

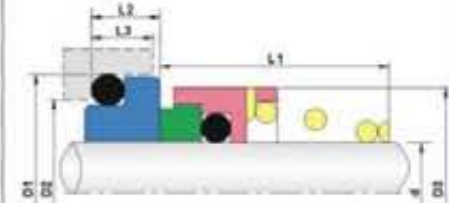

STOCK MATERIALS AND FACE MATERIAL CODE

Rotary Face	Stationary Face
CAR	CER
CAR	SIC
SIC	SIC

Elastomers: VIT, EPDM, NBR

规格/Size (公制/Metric)	D1	D2	D3	L1	L2	L3
10.0	19.2	15.5	19.0	15.5	6.6	5.0
12.0	21.6	17.5	21.0	15.5	5.6	5.0
14.0	24.6	20.5	23.0	15.5	5.6	5.0
15.0	24.6	20.5	24.0	15.5	6.6	5.0
16.0	28.0	22.0	26.0	17.5	7.5	6.5
18.0	30.0	24.0	29.0	18.5	8.0	6.5
19.0	31.0	25.0	31.0	20.0	7.5	6.5
20.0	35.0	29.5	31.0	20.0	7.5	6.5
22.0	35.0	29.5	33.0	21.5	7.5	6.5
24.0	38.0	32.0	35.0	23.0	7.5	6.5
25.0	38.0	32.0	36.0	24.5	7.5	6.5
26.0	40.0	34.0	37.0	24.5	8.0	6.5
28.0	42.0	36.0	40.0	24.5	9.0	6.5
30.0	45.0	39.2	43.0	24.5	10.5	6.5
32.0	48.0	42.2	46.0	28.0	10.5	6.5
35.0	52.0	46.2	49.0	28.0	11.0	6.5
38.0	55.0	49.2	53.0	31.0	10.3	6.5
40.0	58.0	52.2	56.0	34.0	10.8	6.5
42.0	62.0	53.3	59.0	35.0	12.0	8.0
43.0	62.0	54.3	59.0	35.0	12.0	8.0
45.0	64.0	55.3	61.0	36.5	11.6	8.0
48.0	68.4	59.7	64.0	42.0	11.6	8.0
50.0	69.3	60.8	66.0	43.0	11.6	8.0
55.0	75.4	66.5	71.0	47.0	13.3	8.0
58.0	78.4	69.5	76.0	50.0	13.3	8.0
60.0	80.4	71.5	78.0	51.0	13.3	8.0
65.0	85.4	76.5	84.0	52.0	13.0	8.0
68.0	91.5	82.7	88.0	53.0	13.7	8.0
70.0	92.0	83.0	90.0	54.0	13.0	8.0
75.0	99.0	92.2	98.0	55.0	14.0	8.0
80.0	104.0	95.2	100.0	58.0	15.0	8.0

TB80D

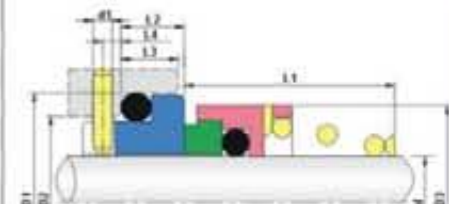

STOCK MATERIALS AND FACE MATERIAL CODE

Rotary Face	Stationary Face
CAR	CER
CAR	SIC
SIC	SIC

Elastomers: VIT, EPDM, NBR

规格/Size (公制/Metric)	D1	D2	D3	L1	L2	L3	d1	L4
10	21.00	17.00	19.00	15.50	10.00	5.50	3.00	5.00
12	23.00	19.00	21.00	16.00	10.00	5.50	3.00	5.00
14	25.00	21.00	23.00	16.50	10.00	5.50	3.00	5.00
16	27.00	23.00	26.00	18.00	10.00	5.50	3.00	5.00
18	33.00	27.00	29.00	19.50	11.50	7.00	3.00	5.00
20	35.00	29.00	31.00	22.00	11.50	7.00	3.00	5.00
22	37.00	31.00	33.00	21.50	11.50	7.00	3.00	5.00
24	39.00	33.00	35.00	23.50	11.50	7.00	3.00	5.00
25	40.00	34.00	36.00	26.50	11.50	7.00	3.00	5.00
28	43.00	37.00	40.00	26.50	11.50	7.00	3.00	5.00
30	45.00	39.00	43.00	26.50	11.50	7.00	3.00	5.00
32	48.00	42.00	46.00	28.50	11.50	7.00	3.00	5.00
35	50.00	44.00	49.00	28.50	11.50	7.00	3.00	5.00
38	56.00	49.00	53.00	33.50	14.00	8.00	4.00	5.00
40	58.00	51.00	56.00	36.00	14.00	8.00	4.00	5.00
43	61.00	54.00	59.00	38.50	14.00	8.00	4.00	5.00
45	63.00	56.00	61.00	39.50	14.00	8.00	4.00	5.00
48	66.00	59.00	64.00	46.00	14.00	8.00	4.00	5.00
50	70.00	62.00	66.00	45.00	15.00	8.50	4.00	5.00
53	73.00	65.00	69.00	47.00	15.00	8.50	4.00	5.00
55	75.00	67.00	71.00	49.00	15.00	8.50	4.00	5.00
58	78.00	70.00	76.00	55.00	15.00	8.50	4.00	5.00
60	80.00	72.00	78.00	55.00	15.00	8.50	4.00	5.00
65	85.00	77.00	84.00	55.00	15.00	8.50	4.00	5.00
68	90.00	81.00	88.00	55.00	18.00	9.50	4.00	5.00
70	92.00	83.00	90.00	57.00	18.00	9.50	4.00	5.00
75	97.00	88.00	98.00	62.00	18.00	9.50	4.00	5.00
80	105.00	95.00	100.00	61.80	18.20	10.00	4.00	5.00



TB120

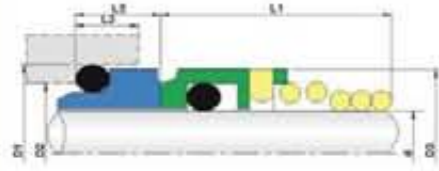

STOCK MATERIALS AND FACE MATERIAL CODE

Rotary Face	Stationary Face
SS304	CAR
SS304	SIC
SIC	CAR
SIC	SIC

Elastomers: VIT, EPDM, NBR

规格/Size (公制/Metric)	D1	D2	D3	L1	L2	L3
10	18.10	14.0	19.00	15.00	5.50	4.00
11	20.60	16.5	21.00	18.00	5.50	4.00
12	20.60	16.5	21.00	18.00	5.50	4.00
13	23.10	19.0	23.00	22.00	6.00	4.00
14	23.10	19.0	23.00	22.00	6.00	4.00
15	26.90	21.0	24.00	22.00	7.00	5.00
16	26.90	21.0	26.00	23.00	7.00	5.00
18	30.90	25.0	29.00	24.00	7.00	5.00
19	30.90	25.0	31.00	25.00	8.00	5.00
20	30.90	25.0	31.00	25.00	8.00	5.00
21	35.40	30.0	33.00	25.00	8.00	5.00
22	35.40	30.0	33.00	25.00	8.00	5.50
23	35.40	30.0	35.00	27.00	8.00	5.50
24	35.40	30.0	35.00	27.00	8.00	5.50
25	38.20	33.0	36.00	27.00	8.50	5.50
26	38.20	33.0	36.00	27.00	8.50	5.50
28	43.30	38.0	40.00	29.00	9.00	5.50
30	43.30	38.0	43.00	30.00	9.00	5.50
32	43.30	38.0	46.00	30.00	9.00	5.50
33	53.50	45.0	46.00	39.00	11.50	7.50
34	53.50	45.0	49.00	39.00	11.50	7.50
35	53.50	45.0	49.00	39.00	11.50	7.50
36	53.50	45.0	49.00	39.00	11.50	7.50
37	53.50	45.0	49.00	39.00	11.50	7.50
38	60.50	52.0	53.00	39.00	11.50	7.50
40	60.50	52.0	56.00	39.00	11.50	7.50
42	60.50	52.0	59.00	39.00	11.50	7.50
43	60.50	52.0	59.00	39.00	11.50	7.50
44	65.50	57.0	61.00	41.00	11.50	7.50
45	65.50	57.0	61.00	41.00	11.50	7.50
48	65.50	57.0	64.00	41.00	11.50	7.50
50	72.50	64.0	66.00	45.00	11.50	7.50
55	72.50	64.0	71.00	47.00	11.50	7.50
60	79.30	72.0	78.00	49.00	11.50	7.50
65	84.50	77.0	84.00	51.00	11.50	7.50
70	89.50	82.0	89.00	51.00	11.50	7.50
75	94.50	87.0	98.00	57.00	11.50	7.50
80	99.50	92.0	100.00	59.00	11.50	7.50
85	105.50	98.0	107.50	59.00	13.50	8.00
90	111.50	105.0	111.00	62.00	13.50	8.00
95	116.50	110.0	119.00	62.00	13.50	8.00
100	119.50	114.0	123.80	75.00	13.50	8.00

TB120D

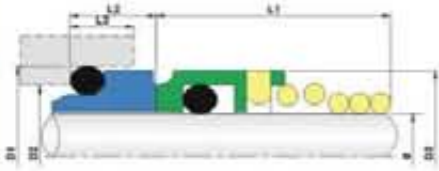

STOCK MATERIALS AND FACE MATERIAL CODE

Rotary Face	Stationary Face
SS304	CAR
SS304	SIC
SIC	CAR
SIC	SIC

Elastomers: VIT, EPDM, NBR

规格/Size (公制/Metric)	D1	D2	D3	L1	L2	L3
10	21.00	17.0	19.00	15.00	7.00	4.00
12	23.00	19.0	21.00	18.00	7.00	4.00
14	25.00	21.0	23.00	22.00	7.00	4.00
16	27.00	23.0	26.00	23.00	7.00	4.00
18	33.00	27.0	29.00	24.00	10.00	5.00
20	35.00	29.0	31.00	25.00	10.00	5.00
22	37.00	31.0	33.00	25.00	10.00	5.50
24	39.00	33.0	35.00	27.00	10.00	5.50
25	40.00	34.0	36.00	27.00	10.00	5.50
28	43.00	37.0	40.00	29.00	10.00	5.50
30	45.00	39.0	43.00	30.00	10.00	5.50
32	48.00	42.0	46.00	30.00	10.00	5.50
33	48.00	42.0	46.00	39.00	10.00	5.50
35	50.00	44.0	49.00	39.00	10.00	5.50
38	56.00	49.0	53.00	42.00	13.00	6.00
40	58.00	51.0	56.00	42.00	13.00	6.00
43	61.00	54.0	59.00	47.00	13.00	6.00
45	63.00	56.0	61.00	47.00	13.00	6.00
48	66.00	59.0	64.00	47.00	13.00	6.00
50	70.00	62.0	66.00	46.00	14.00	6.00
53	73.00	65.0	69.00	56.00	14.00	6.00
55	75.00	67.0	71.00	56.00	14.00	6.00
58	78.00	70.0	76.00	56.00	14.00	6.00
60	80.00	72.0	78.00	56.00	14.00	6.00
63	83.00	75.0	81.00	56.00	14.00	6.00
65	85.00	77.0	84.00	66.00	14.00	6.00
68	90.00	81.0	88.00	64.00	16.00	7.00
70	92.00	83.0	89.60	64.00	16.00	7.00
75	97.00	88.0	98.00	64.00	16.00	7.00
80	105.00	95.0	100.00	72.00	18.00	7.00
85	110.00	100.0	107.50	72.00	18.00	7.00
90	115.00	105.0	111.00	72.00	18.00	7.00
95	120.00	110.0	119.00	72.00	18.00	7.00
100	125.00	115.0	123.80	72.00	18.00	7.00

TB155							
规格/Size (公制/Metric)	d	D3	D2	D1	L1	L2	L3
10	10	20	14.0	18.1	15	5.5	7.0
11	11	22	16.5	20.6	18	5.5	7.0
12	12	22	16.5	20.6	18	5.5	7.0
13	13	25	19.0	23.1	22	6.0	7.5
14	14	25	19.0	23.1	22	6.0	7.5
15	15	29	21.0	26.9	22	7.0	9.2
16	16	29	21.0	26.9	23	7.0	9.2
17	17	29	21.0	26.9	23	7.0	9.2
18	18	33	25.0	30.9	24	8.0	10.0
19	19	33	25.0	30.9	25	8.0	10.0
20	20	33	25.0	30.9	25	8.0	10.0
21	21	38	30.0	35.4	25	8.0	10.0
22	22	38	30.0	35.4	25	8.0	10.0
23	23	38	30.0	35.4	27	8.0	10.0
24	24	38	30.0	35.4	27	8.0	10.0
25	25	40	33.0	38.2	27	8.5	10.0
28	28	46	38.0	43.3	29	9.0	11.0
29	29	46	38.0	43.3	30	9.0	11.0
30	30	46	38.0	43.3	30	9.0	11.0
32	32	46	38.0	43.3	30	9.0	11.0
33	33	48	45.0	53.5	39	11.5	13.0
35	35	50	45.0	53.5	39	11.5	13.0
38	38	56	52.0	60.5	39	11.5	13.0
40	40	58	52.0	60.5	39	11.5	13.0

TB155A							
规格/Size (公制/Metric)	d	D3	D2	D1	L1	L2	L3
10	10	20	17	21	15	7	8.5
12	12	22	19	23	18	7	8.5
14	14	25	21	25	22	7	8.5
16	16	29	23	27	23	7	8.5
18	18	33	27	33	24	10	12.0
20	20	33	29	35	25	10	12.0
22	22	38	31	37	25	10	12.0
24	24	38	33	39	27	10	12.0
25	25	40	34	40	27	10	12.0
28	28	46	37	43	29	10	12.0
30	30	46	39	45	30	10	12.0
32	32	46	42	48	30	10	11.5
33	33	48	42	48	39	10	11.5
35	35	50	44	50	39	10	11.5
38	38	56	49	58	42.2	13	15.0
40	40	58	51	58	42.2	13	15.0

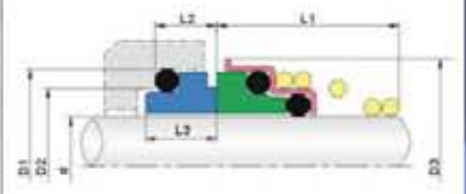

STOCK MATERIALS AND FACE MATERIAL CODE

Rotary Face	Stationary Face
99% CER	CAR
SIC	CAR
SIC	SIC

Elastomers: VIT, EPDM, NBR

TB155 / 155A

规格/Size (公制/Metric)	D3	D1	L1	L3
10	20	21	17.5	10.0
12	22	23	17.5	10.0
14	25	25	17.5	10.0
16	27	27	19.5	10.0
18	30	33	20.5	11.5
20	32	35	22.0	11.5
22	35	37	23.5	11.5
24	38	39	25.0	11.5
25	40	40	26.5	11.5
28	43	43	26.5	11.5
30	47	45	25.0	11.5
32	48	48	28.5	11.5
35	53	50	28.5	11.5
38	56	56	32.0	14.0

规格/Size (英寸)	D3	D1	L1	L3
0.394	0.787	0.827	0.689	0.394
0.472	0.866	0.906	0.689	0.394
0.551	0.984	0.984	0.689	0.394
0.630	1.063	1.063	0.768	0.394
0.709	1.181	1.299	0.807	0.453
0.787	1.260	1.378	0.866	0.453
0.866	1.378	1.457	0.925	0.453
0.945	1.496	1.535	0.984	0.453
0.984	1.575	1.575	1.043	0.453
1.102	1.693	1.639	1.043	0.453
1.181	1.772	1.772	0.984	0.453
1.260	1.850	1.890	1.122	0.453
1.378	1.969	1.969	1.122	0.453
1.496	2.205	2.205	1.260	0.551

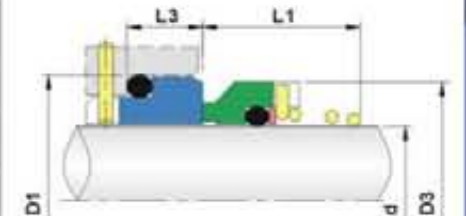

STOCK MATERIALS AND FACE MATERIAL CODE

Rotary Face	Stationary Face
CAR	SIC

Elastomers: VIT, EPDM, NBR

TBM2N



TBM3 / M3A

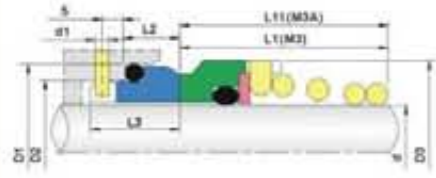

STOCK MATERIALS AND FACE MATERIAL CODE	
Rotary Face	Stationary Face
SS304	SiC
Elastomers: VIT, EPDM, NBR	

规格/Size (公制/Metric)	d	D3	D2	D1	d1	L1	L11	L2	L3
10	10	19	17	21	3	15.5	15.5	10.0	17.5
12	12	21	19	23	3	16.0	15.5	10.0	17.5
14	14	23	21	25	3	16.5	15.5	10.0	17.5
16	16	26	23	27	3	18.0	17.5	10.0	17.5
18	18	29	27	33	3	19.5	18.5	11.5	19.5
20	20	31	29	35	3	22.0	20.0	11.5	19.5
22	22	33	31	37	3	21.5	21.5	11.5	19.5
24	24	35	33	39	3	23.5	23.0	11.5	19.5
25	25	36	34	40	3	26.5	24.5	11.5	19.5
28	28	40	37	43	3	26.5	24.5	11.5	19.5
30	30	43	39	45	3	26.5	24.5	11.5	19.5
32	32	46	42	48	3	28.5	28.0	11.5	19.5
33	33	47	42	48	3	28.5	-	11.5	19.5
35	35	49	44	50	3	28.5	28.0	11.5	19.5
38	38	53	49	56	4	33.5	31.0	14.0	22.0
40	40	56	51	58	4	36.0	34.0	14.0	22.0
43	43	59	54	61	4	38.5	-	14.0	22.0
45	45	61	56	63	4	39.5	36.5	14.0	22.0
48	48	64	59	66	4	46.0	42.0	14.0	22.0
50	50	66	62	70	4	45.0	43.0	15.0	23.0
53	53	69	65	73	4	47.0	-	15.0	23.0
55	55	71	67	75	4	49.0	47.0	15.0	23.0
58	58	76	70	78	4	55.0	50.0	15.0	23.0
60	60	78	72	80	4	55.0	51.0	15.0	23.0
63	63	83	75	83	4	55.0	-	15.0	23.0
65	65	84	77	85	4	55.0	52.0	15.0	23.0
68	68	88	81	90	4	55.0	53.0	18.0	26.0
70	70	90	83	92	4	57.0	54.0	18.0	26.0
75	75	98	88	97	4	62.0	55.0	18.0	26.0
80	80	100	95	105	4	61.8	58.0	18.2	26.2

TBM37 / M37G

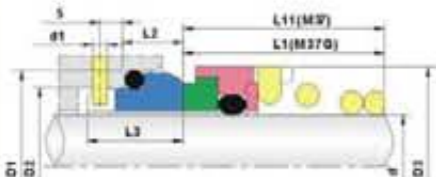

STOCK MATERIALS AND FACE MATERIAL CODE	
Rotary Face	Stationary Face
CAR	SiC
SiC	SiC
Elastomers: VIT, EPDM, NBR	

规格/Size (公制/Metric)	d	D3	D2	D1	d1	L1	L11	L2	L3
10	10	20	17	21	3	16.9	-	10.0	17.5
12	12	22	19	23	3	17.4	-	10.0	17.5
14	14	24	21	25	3	17.4	16.5	10.0	17.5
16	16	26	23	27	3	19.5	16.5	10.0	17.5
18	18	31	27	33	3	20.5	18.0	11.5	19.5
20	20	34	29	35	3	22.0	19.0	11.5	19.5
22	22	36	31	37	3	23.5	20.5	11.5	19.5
24	24	38	33	39	3	25.0	22.0	11.5	19.5
25	25	39	34	40	3	26.5	23.5	11.5	19.5
28	28	42	37	43	3	26.5	24.5	11.5	19.5
30	30	44	39	45	3	25.0	24.5	11.5	19.5
32	32	46	42	48	3	28.5	28.0	11.5	19.5
33	33	47	42	48	3	-	-	11.5	19.5
35	35	49	44	50	3	28.5	28.0	11.5	19.5
38	38	54	49	56	4	32.2	31.0	14.0	22.0
40	40	56	51	58	4	34.7	34.0	14.0	22.0
43	43	59	54	61	4	-	-	14.0	22.0
45	45	61	56	63	4	39.2	36.5	14.0	22.0
48	48	64	59	66	4	44.7	42.0	14.0	22.0
50	50	66	62	70	4	45.7	43.0	15.0	23.0
53	53	69	65	73	4	-	-	15.0	23.0
55	55	71	67	75	4	49.0	47.0	15.0	23.0
58	58	78	70	78	4	52.0	50.0	15.0	23.0
60	60	79	72	80	4	53.0	51.0	15.0	23.0
63	63	83	75	83	4	-	-	15.0	23.0
65	65	85	77	85	4	54.3	52.0	15.0	23.0
68	68	88	81	90	4	55.3	52.7	18.0	26.0
70	70	90	83	92	4	56.3	54.0	18.0	26.0
75	75	98	88	97	4	56.3	54.0	18.0	26.0
80	80	103	95	105	4	59.3	58.0	18.2	26.2

TB250

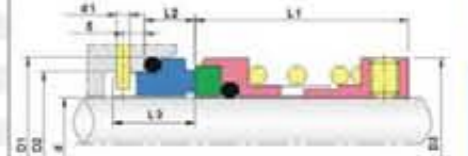

STOCK MATERIALS AND FACE MATERIAL CODE	
Rotary Face	Stationary Face
CAR	SiC
SiC	SiC
Elastomers: VIT, EPDM, NBR	

规格/Size (公制/Metric)	d	D3	D2	D1	d1	L1	L2	L3
20	20	34	29	35	3	41	13	21
22	22	36	31	37	3	41	13	21
24	24	38	33	39	3	43	13	21
25	25	39	34	40	3	43	13	21
28	28	42	37	43	3	45	13	21
30	30	44	39	45	3	45	13	21
32	32	46	42	48	3	45	13	21
33	33	47	42	48	3	45	13	21
35	35	49	44	50	3	49	13	21
38	38	54	50	56	4	53	13	21
40	40	56	52	58	4	55	13	21
43	43	59	55	61	4	55	13	21
45	45	61	57	63	4	55	13	21
48	48	64	60	66	4	55	13	21
50	50	66	62	68	4	60	13	21
53	53	69	65	71	4	61	13	21
55	55	71	67	73	4	61	13	21
58	58	76	70	79	4	63	16	24
60	60	78	72	81	4	63	16	24
63	63	81	75	84	4	63	16	24
65	65	83	77	86	4	67	16	24
68	68	87	81	90	4	67	16	24
70	70	90	83	92	4	68	16	24
75	75	95	83	97	4	72	16	24
80	80	100	96	105	4	72	16	24
85	85	105	101	110	4	77	16	24
90	90	112	106	115	4	77	16	24
95	95	119	111	120	4	82	16	24
100	100	124	116	125	4	82	16	24

规格/Size (公制/Metric)	Code	D1	D2	D3	D4	L	L1	L3
20	0200	37.0	31.0	34.50	40.0	61.0	38.0	24.0
22	0220	39.0	33.0	34.93	42.0	61.0	38.0	24.0
25	0250	40.0	34.0	41.00	45.0	61.0	38.0	24.0
28	0282	44.0	38.0	42.00	48.0	63.0	40.0	24.0
30	0300	47.0	41.0	45.50	53.0	64.0	40.0	26.0
32	0320	48.0	42.0	47.00	55.0	64.0	40.0	26.0
35	0350	51.0	45.0	50.00	58.0	64.0	40.0	26.0
38	0380	54.0	48.0	53.00	62.0	69.0	45.0	26.0
40	0400	57.0	51.0	55.00	64.0	69.0	45.0	26.0
42	0420	60.5	54.5	55.50	66.0	74.0	50.0	26.0
45	0450	61.0	55.0	60.00	69.0	74.0	50.0	26.0
48	0480	64.0	58.0	61.91	72.0	79.0	55.0	26.0
50	0500	67.0	61.0	66.00	75.0	79.0	55.0	26.0
52	0520	70.0	64.0	68.00	77.0	82.0	58.0	26.0
55	0550	73.0	67.0	71.00	80.0	82.0	58.0	26.0
58	0580	76.0	70.0	74.00	83.0	82.0	58.0	26.0
60	0600	80.0	74.0	77.00	85.0	86.0	60.0	28.0
62	0620	83.0	77.0	78.00	87.0	86.0	60.0	28.0
65	0650	86.0	80.0	82.00	90.0	88.0	62.0	28.0
68	0680	89.0	83.0	84.00	93.0	88.0	62.0	28.0
70	0700	89.0	83.0	87.00	95.0	91.0	65.0	28.0
75	0750	95.0	89.0	91.50	100.0	91.0	65.0	28.0
80	0800	99.0	93.0	99.50	110.0	96.0	70.0	28.0
85	0850	105.0	99.0	105.50	115.0	96.0	70.0	28.0
90	0900	111.0	105.0	110.50	120.0	96.0	70.0	28.0
95	0950	114.0	108.0	115.50	130.0	101.0	75.0	28.0
100	1000	118.0	112.0	120.00	135.0	101.0	75.0	28.0
105	1050	132.0	126.0	128.00	140.0	103.0	75.0	30.0
110	1100	137.0	131.0	133.00	145.0	108.0	80.0	30.0
115	1150	140.0	134.0	137.50	150.0	108.0	80.0	30.0
120	1200	147.0	141.0	144.00	160.0	113.0	85.0	30.0
125	1250	150.0	144.0	149.00	165.0	113.0	85.0	30.0
130	1300	156.0	150.0	154.00	170.0	113.0	85.0	30.0

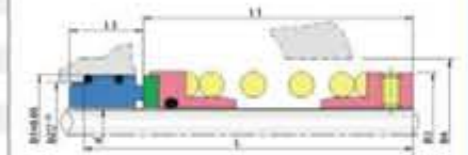

STOCK MATERIALS AND FACE MATERIAL CODE	
Rotary Face	Stationary Face
SS304	CAR
SiC	CAR
SiC	SiC
Elastomers: VIT, EPDM, NBR	

TB980



TB950

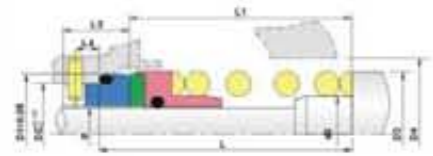

STOCK MATERIALS AND FACE MATERIAL CODE

Rotary Face	Stationary Face
SS304	SiC

Elastomers: VIT, EPDM, NBR

规格/Size (公制/Metric)	D1	D2	D3	D4	d0	L	L1	L3	L4
20	33.32	29.06	34.5	37.0	24.00	36.50	27.5	15.0	4.0
25	39.85	33.84	41.0	43.0	28.57	40.00	30.0	16.0	4.0
28	43.05	37.01	42.0	46.0	31.75	41.50	31.5	16.0	4.0
30	44.63	38.61	45.5	47.5	33.32	41.50	31.5	16.0	4.0
32	46.32	40.28	47.0	49.0	34.92	44.50	34.5	16.0	4.0
35	49.48	43.46	50.0	52.5	38.10	47.50	37.5	16.0	4.0
38	52.56	46.63	53.0	55.5	42.88	47.50	37.5	16.0	4.0
40	54.25	48.13	55.0	57.0	44.45	47.50	37.5	16.0	4.0
42	55.83	49.81	55.5	58.5	46.02	47.50	37.5	16.0	4.0
45	59.02	52.98	60.0	62.0	49.20	47.50	37.5	16.0	4.0
50	65.37	59.33	66.0	68.5	53.97	55.50	45.5	18.0	5.0
55	70.03	64.01	71.0	73.0	58.72	57.00	47.0	18.0	5.0
60	76.38	70.36	77.0	81.0	65.07	60.50	50.5	18.0	5.0
65	81.23	75.21	82.0	85.5	69.85	63.50	53.5	18.0	5.0
70	85.90	79.88	87.0	90.5	74.60	63.50	53.5	18.0	5.0
75	90.77	84.73	91.5	97.0	79.37	66.60	56.6	18.0	5.0
80	100.29	94.26	99.5	103.0	85.73	73.00	63.0	18.0	5.0
85	104.77	98.93	105.5	108.0	90.00	73.00	63.0	18.0	5.0
90	109.82	103.78	110.5	114.5	95.25	78.00	68.0	18.0	5.0
95	114.30	108.46	115.5	119.0	100.00	78.00	68.0	18.0	5.0
100	119.33	113.31	120.0	124.0	104.77	78.00	68.0	18.0	5.0
105	127.00	121.16	128.0	132.0	111.00	82.50	72.5	18.0	5.0
110	131.77	126.01	133.0	137.0	116.00	82.50	72.5	18.0	5.0
115	136.52	130.68	137.5	142.0	121.00	82.50	72.5	18.0	5.0
120	142.87	137.03	144.0	147.0	126.00	89.00	79.0	18.0	5.0

规格/Size (英制/Inch)	D1	D2	D3	D4	d0	L	L1	L3	L4
0.625	28.57	24.31	29.00	31.5	19.05	33.5	24.5	15.0	4.0
0.750	31.75	27.48	32.50	35.0	22.22	33.5	24.5	15.0	4.0
0.875	34.93	30.66	34.93	38.0	25.40	35.0	26.0	15.0	4.0
1.000	39.85	33.84	38.10	43.0	28.57	40.0	30.0	16.0	4.0
1.125	43.05	37.01	42.86	46.0	31.75	41.5	31.5	16.0	4.0
1.250	46.32	40.28	46.00	49.0	34.92	44.5	34.5	16.0	4.0
1.375	49.48	43.46	49.21	52.5	38.10	47.5	37.5	16.0	4.0
1.500	52.56	46.63	52.39	55.5	42.88	47.5	37.5	16.0	4.0
1.625	55.83	49.81	55.50	58.5	46.02	47.5	37.5	16.0	4.0
1.750	59.02	52.98	58.74	62.0	49.20	47.5	37.5	16.0	4.0
1.875	63.68	57.66	61.91	66.5	52.37	52.5	42.5	18.0	5.0
2.000	66.85	60.83	66.68	70.0	55.57	55.5	45.5	18.0	5.0
2.125	70.03	64.01	69.85	73.0	58.72	57.0	47.0	18.0	5.0
2.250	73.20	67.18	73.02	76.0	61.90	57.0	47.0	18.0	5.0
2.375	76.38	70.36	76.20	81.0	65.07	60.5	50.5	18.0	5.0
2.500	79.56	73.53	79.38	84.0	68.28	60.5	50.5	18.0	5.0
2.625	82.73	76.71	82.55	87.5	71.42	63.5	53.5	18.0	5.0
2.750	85.90	79.88	85.72	90.5	74.60	63.5	53.5	18.0	5.0
2.875	89.08	83.06	90.00	95.5	77.77	66.5	56.5	18.0	5.0
3.000	95.43	89.41	95.25	98.5	80.97	73.0	63.0	18.0	5.0
3.250	101.78	95.76	101.60	105.0	87.30	73.0	63.0	18.0	5.0
3.500	108.13	102.11	107.95	111.0	93.67	73.0	63.0	18.0	5.0
4.000	124.00	117.98	124.50	128.5	107.95	82.5	72.5	18.0	5.0

TB960

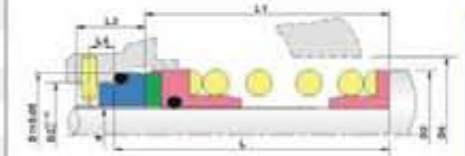

STOCK MATERIALS AND FACE MATERIAL CODE

Rotary Face	Stationary Face
SS304	CAR
SiC	CAR
SiC	SiC

Elastomers: -

规格/Size (公制/Metric)	D1	D2	D3	D4	L	L1	L3	L4
20	33.32	29.06	34.5	37.0	38.0	29.9	15.0	4.0
25	39.85	33.84	41.0	43.0	41.5	31.5	16.0	4.0
28	43.05	37.01	42.0	46.0	43.0	33.0	16.0	4.0
30	44.63	38.61	45.5	47.5	43.0	33.0	16.0	4.0
32	46.32	40.28	47.0	49.0	46.0	36.0	16.0	4.0
35	49.48	43.46	50.0	52.5	49.0	39.0	16.0	4.0
38	52.56	46.63	53.0	55.5	49.0	39.0	16.0	4.0
40	54.25	48.13	55.0	57.0	49.0	39.0	16.0	4.0
42	55.83	49.81	55.5	58.5	49.0	39.0	16.0	4.0
45	59.02	52.98	60.0	62.0	49.0	39.0	16.0	4.0
50	65.37	59.33	66.0	68.5	57.0	47.0	18.0	5.0
55	70.03	64.01	71.0	73.0	58.5	48.5	18.0	5.0
60	76.38	70.36	77.0	81.0	62.0	52.0	18.0	5.0
65	81.23	75.21	82.0	85.5	65.0	55.0	18.0	5.0
70	85.90	79.88	87.0	90.5	65.0	55.0	18.0	5.0
75	90.77	84.73	91.5	97.0	70.0	60.0	18.0	5.0
80	100.29	94.26	99.5	103.0	76.0	66.0	18.0	5.0
85	104.77	98.93	105.5	108.0	76.0	66.0	18.0	5.0
90	109.82	103.78	110.5	114.5	81.0	71.0	18.0	5.0
95	114.30	108.46	115.5	119.0	81.0	71.0	18.0	5.0
100	119.33	113.31	120.0	124.0	81.0	71.0	18.0	5.0
105	127.00	121.16	128.0	132.0	85.5	75.5	18.0	5.0
110	131.77	126.01	133.0	137.0	85.5	75.5	18.0	5.0
115	136.52	130.68	137.5	142.0	85.5	75.5	18.0	5.0
120	142.87	137.03	144.0	147.0	92.0	82.0	18.0	5.0

规格/Size (英制/Inch)	D1	D2	D3	D4	L	L1	L3	L4
0.625	28.57	28.57	29.00	31.5	35.0	26.0	15.0	4.0
0.750	31.75	31.75	32.50	35.0	35.0	26.0	15.0	4.0
0.875	34.93	34.93	34.93	38.0	36.5	27.5	15.0	4.0
1.000	39.85	39.85	38.10	43.0	41.5	31.5	16.0	4.0
1.125	43.05	43.05	42.86	46.0	43.0	33.0	16.0	4.0
1.250	46.32	46.32	46.00	49.0	46.0	36.0	16.0	4.0
1.375	49.48	49.48	49.21	52.5	49.0	39.0	16.0	4.0
1.500	52.56	52.56	52.39	55.5	49.0	39.0	16.0	4.0
1.625	55.83	55.83	55.50	58.5	49.0	39.0	16.0	4.0
1.750	59.02	59.02	58.74	62.0	49.0	39.0	16.0	4.0
1.875	63.68	63.68	61.91	66.5	54.0	44.0	18.0	5.0
2.000	66.85	66.85	66.68	70.0	57.0	47.0	18.0	5.0
2.125	70.03	70.03	69.85	73.0	58.5	48.5	18.0	5.0
2.250	73.20	73.20	73.02	76.0	58.5	48.5	18.0	5.0
2.375	76.38	76.38	76.20	81.0	62.0	52.0	18.0	5.0
2.500	79.56	79.56	79.38	84.0	62.0	52.0	18.0	5.0
2.625	82.73	82.73	82.55	87.5	65.0	55.0	18.0	5.0
2.750	85.90	85.90	85.72	90.5	65.0	55.0	18.0	5.0
2.875	89.08	89.08	90.00	95.5	70.0	60.0	18.0	5.0
3.000	95.43	95.43	95.25	98.5	76.0	66.0	18.0	5.0
3.250	101.78	101.78	101.60	105.0	76.0	66.0	18.0	5.0
3.500	108.13	108.13	107.95	111.0	76.0	66.0	18.0	5.0
4.000	124.00	124.00	124.50	128.5	85.5	75.5	18.0	5.0



TB970

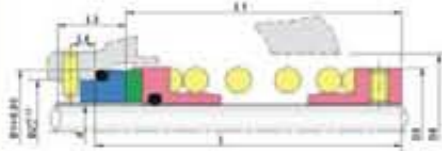

STOCK MATERIALS AND FACE MATERIAL CODE	
Rotary Face	Stationary Face
SS304	CAR
SIC	CAR
SIC	SIC
Elastomers: -	

规格/Size (公制/Metric)	D1	D2	D3	D4	L	L1	L3	L4
20	33.32	29.06	34.5	37.0	44.5	35.5	15.0	4.0
25	39.85	33.84	41.0	43.0	49.0	39.0	16.0	4.0
28	43.05	37.01	42.0	46.0	51.0	41.0	16.0	4.0
30	44.63	38.61	45.5	47.5	51.0	41.0	16.0	4.0
32	46.32	40.28	47.0	49.0	54.0	44.0	16.0	4.0
35	49.48	43.46	50.0	52.5	57.0	47.0	16.0	4.0
38	52.56	46.63	53.0	55.5	57.0	47.0	16.0	4.0
40	54.25	48.13	55.0	57.0	57.0	47.0	16.0	4.0
42	55.83	49.81	55.5	58.5	57.0	47.0	16.0	4.0
45	59.02	52.98	60.0	62.0	57.0	47.0	16.0	4.0
50	65.37	59.33	66.0	68.5	68.5	58.5	18.0	5.0
55	70.03	64.01	71.0	73.0	70.0	60.0	18.0	5.0
60	76.38	70.36	77.0	81.0	73.0	63.0	18.0	5.0
65	81.23	75.21	82.0	85.5	76.0	66.0	18.0	5.0
70	85.90	79.88	87.0	90.5	76.0	66.0	18.0	5.0
75	90.77	84.73	91.5	97.0	81.0	71.0	18.0	5.0
80	100.29	94.26	99.5	103.0	87.5	77.5	18.0	5.0
85	104.77	98.93	105.5	108.0	87.5	77.5	18.0	5.0
90	109.82	103.78	110.5	114.5	92.0	82.0	18.0	5.0
95	114.30	108.46	115.5	119.0	92.0	82.0	18.0	5.0
100	119.33	113.31	120.0	124.0	92.0	82.0	18.0	5.0
105	127.00	121.16	128.0	132.0	98.5	88.5	18.0	5.0
110	131.77	126.01	133.0	137.0	85.5	88.5	18.0	5.0
115	136.52	130.68	137.5	142.0	85.5	88.5	18.0	5.0
120	142.87	137.03	144.0	147.0	105.0	95.0	18.0	5.0

规格/Size (英制/Inch)	D1	D2	D3	D4	L	L1	L3	L4
0.625	28.57	24.31	29.00	31.5	41.5	32.5	15.0	4.0
0.750	31.75	27.48	32.50	35.0	41.5	32.5	15.0	4.0
0.875	34.93	30.66	34.93	38.0	44.5	35.5	15.0	4.0
1.000	39.85	33.84	38.10	43.0	49.0	39.0	16.0	4.0
1.125	43.05	37.01	42.86	46.0	51.0	41.0	16.0	4.0
1.250	46.32	40.28	46.00	49.0	54.0	44.0	16.0	4.0
1.375	49.48	43.46	49.21	52.5	57.0	47.0	16.0	4.0
1.500	52.56	46.63	52.39	55.5	57.0	47.0	16.0	4.0
1.625	55.83	49.81	55.50	58.5	57.0	47.0	16.0	4.0
1.750	59.02	52.98	58.74	62.0	57.0	47.0	16.0	4.0
1.875	63.68	57.66	61.91	66.5	65.0	55.0	18.0	5.0
2.000	66.85	60.83	66.68	70.0	68.5	58.5	18.0	5.0
2.125	70.03	64.01	69.85	73.0	70.0	60.0	18.0	5.0
2.250	73.20	67.18	73.02	76.0	70.0	60.0	18.0	5.0
2.375	76.38	70.36	76.20	81.0	73.0	63.0	18.0	5.0
2.500	79.56	73.53	79.38	84.0	73.0	63.0	18.0	5.0
2.625	82.73	76.71	82.55	87.5	76.0	66.0	18.0	5.0
2.750	85.90	79.88	85.72	90.5	76.0	66.0	18.0	5.0
2.875	89.08	83.06	90.00	95.5	81.0	71.0	18.0	5.0
3.000	95.43	89.41	95.25	98.5	87.5	77.5	18.0	5.0
3.250	101.78	95.76	101.60	105.0	87.5	77.5	18.0	5.0
3.500	108.13	102.11	107.95	111.0	87.5	77.5	18.0	5.0
4.000	124.00	117.98	124.50	128.5	98.5	88.5	18.0	5.0

TB1527

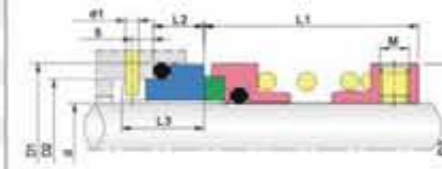

STOCK MATERIALS AND FACE MATERIAL CODE	
Rotary Face	Stationary Face
CAR	SIC
SIC	SIC
Elastomers: VIT, EPDM, NBR	

规格/Size (公制/Metric)	d	D3	D2	D1	d1	L1	L2	L3
18	18	32	27	33	3	35.0	10.0	17.0
20	20	34	29	35	3	35.0	10.0	17.0
22	22	36	31	37	3	35.0	10.0	17.0
24	24	38	33	39	3	40.0	10.0	17.0
25	25	39	34	40	3	40.0	10.0	17.0
28	28	42	37	43	3	40.0	10.0	17.0
30	30	44	39	45	3	40.0	10.0	17.0
32	32	46	42	48	3	45.0	10.0	17.0
33	33	47	42	48	3	45.0	10.0	17.0
35	35	49	44	50	3	45.0	10.0	17.0
38	38	54	49	56	4	44.0	11.0	18.0
40	40	56	51	58	4	44.0	11.0	18.0
43	43	59	54	61	4	49.0	11.0	18.0
45	45	61	56	63	4	49.0	11.0	18.0
48	48	64	59	66	4	49.0	11.0	18.0
50	50	66	62	70	4	47.0	13.0	20.0
53	53	69	65	73	4	57.0	13.0	20.0
55	55	71	67	75	4	57.0	13.0	20.0
58	58	78	70	78	4	57.0	13.0	20.0
60	60	80	72	80	4	57.0	13.0	20.0
63	63	83	75	83	4	57.0	13.0	20.0
65	65	85	77	85	4	67.0	13.0	20.0
68	68	88	81	90	4	64.7	15.3	22.0
70	70	90	83	92	4	64.7	15.3	22.0
75	75	99	88	97	4	64.7	15.3	22.0
80	80	104	95	105	4	74.3	15.7	22.5
85	85	109	100	110	4	74.3	15.7	22.5
90	90	114	105	115	4	74.3	15.7	22.5
95	95	119	110	120	4	74.3	15.7	22.5
100	100	124	115	125	4	74.3	15.7	22.5

TBUS2

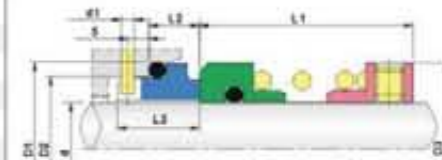

STOCK MATERIALS AND FACE MATERIAL CODE	
Rotary Face	Stationary Face
CAR	SIC
SIC	SIC
Elastomers: VIT, EPDM, NBR	

规格/Size (公制/Metric)	d	D3	D2	D1	d1	L1	L2	L3
20	20	34.5	29.06	33.32	-	37.3	7.2	9.4
25	25	41.0	33.83	39.67	-	40.0	9.2	11.4
30	30	45.5	38.61	44.45	-	41.6	9.2	11.4
35	35	50.0	43.46	49.20	-	48.0	9.2	11.4
38	38	53.0	46.30	52.00	-	62.3	9.2	11.4
40	40	55.0	48.13	53.97	-	48.0	9.2	11.4
45	45	60.0	52.98	58.72	-	48.0	9.2	11.4
50	50	66.0	59.33	65.07	3	59.1	9.2	17.7
55	55	71.0	64.01	69.85	3	60.7	9.2	17.7
60	60	77.0	70.36	76.20	3	63.8	9.2	17.7
65	65	82.0	75.21	80.97	3	67.0	9.2	17.7
70	70	88.0	79.88	85.72	3	67.0	9.2	17.7
75	75	92.0	84.73	90.47	3	71.8	9.2	20.9
80	80	99.5	92.58	98.42	3	78.1	9.2	20.9
85	85	105.5	98.93	104.77	4	78.1	9.2	20.9
90	90	110.5	103.78	109.52	4	82.9	9.2	20.9
95	95	115.5	108.46	114.30	4	82.9	9.2	20.9
100	100	121.0	113.31	119.07	4	82.9	9.2	20.9
105	105	129.0	121.16	127.00	4	89.2	9.2	20.9
110	110	134.0	126.01	131.77	4	89.2	9.2	20.9
115	115	139.0	130.68	136.52	4	89.2	9.2	20.9
120	120	144.0	137.03	142.87	4	95.5	9.2	20.9
125	125	149.0	141.80	147.60	4	98.0	9.8	21.5
130	130	156.5	146.50	152.16	4	100.0	9.8	21.5
135	135	162.0	151.60	157.20	4	102.0	9.8	21.5
140	140	169.0	156.18	161.93	4	105.0	9.8	21.5
145	145	178.0	167.50	177.00	4	113.3	18.7	47.7
150	150	184.0	172.50	182.00	4	117.3	18.7	47.7



TB8-1

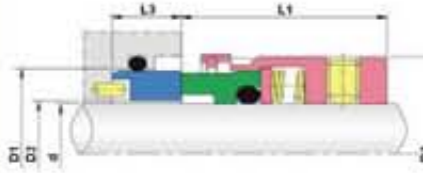

STOCK MATERIALS AND FACE MATERIAL CODE	
Rotary Face	Stationary Face
CAR	SIC
SIC	SIC
Elastomers: VIT, EPDM, NBR	

规格/Size (英制/Inch)	d	D3	D2	D1	L1	L3
0.500	12.7	26.19	14.0	25.60	20.62	7.92
0.625	15.8	30.15	17.5	31.95	19.05	10.31
0.750	19.0	33.32	21.0	35.12	22.23	10.31
0.875	22.2	36.50	24.0	38.30	23.80	10.31
1.000	25.4	39.67	27.5	41.48	25.40	11.10
1.125	28.5	42.85	30.5	44.65	26.97	11.10
1.250	31.7	47.63	33.5	47.83	26.97	11.10
1.375	34.9	50.80	37.0	51.00	28.58	11.10
1.500	38.1	53.98	40.0	54.18	28.58	11.10
1.625	41.2	60.33	43.5	60.53	34.93	12.70
1.750	44.4	63.50	46.5	63.70	34.93	12.70
1.875	47.6	66.68	49.5	66.88	34.93	12.70
2.000	50.8	69.85	53.0	70.05	34.93	12.70
2.125	53.9	76.20	56.0	76.40	42.85	14.27
2.250	57.1	79.38	59.0	79.58	42.85	14.27
2.375	60.3	82.55	62.5	82.75	42.85	14.27
2.500	63.5	85.73	65.5	85.93	42.85	14.27
2.625	66.6	88.90	68.5	85.93	42.85	15.88
2.750	69.8	92.08	72.0	89.10	42.85	15.88
2.875	73.0	95.25	75.0	95.45	42.85	15.88
3.000	76.2	96.82	78.5	98.63	42.85	15.88
3.125	79.3	100.00	81.5	101.80	42.85	19.84
3.250	82.5	104.78	84.5	104.98	42.85	19.84
3.375	85.7	107.95	88.0	108.15	42.85	19.84
3.500	88.9	111.13	91.0	111.33	42.85	19.84
3.625	92.0	114.30	94.0	114.50	42.85	19.84
3.750	95.2	117.48	97.5	117.68	42.85	19.84
3.875	98.4	120.65	100.5	120.85	42.85	19.84
4.000	101.6	123.83	103.5	124.03	42.85	19.84

TB8-1T

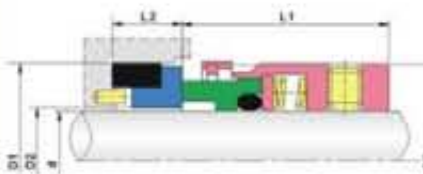

STOCK MATERIALS AND FACE MATERIAL CODE	
Rotary Face	Stationary Face
CAR	SIC
SIC	SIC
Elastomers: PTFE	

规格/Size (英制/Inch)	d	D3	D2	D1	L1	L3
0.500	12.7	23.80	13.4	25.40	23.80	7.9
0.625	15.8	26.97	16.6	31.75	23.80	10.3
0.750	19.0	30.15	19.7	34.93	23.80	10.3
0.875	22.2	33.32	22.9	38.10	23.80	10.3
1.000	25.4	36.50	26.1	41.28	25.40	11.1
1.125	28.5	39.67	29.3	44.45	25.40	11.1
1.250	31.7	42.85	32.4	48.63	25.40	11.1
1.375	34.9	49.20	35.6	50.80	34.93	11.1
1.500	38.1	49.20	38.8	53.98	28.58	11.1
1.625	41.2	57.15	42.4	60.33	29.36	12.7
1.750	44.4	58.72	45.5	63.50	34.93	12.7
1.875	47.6	63.50	48.7	66.68	34.93	12.7
2.000	50.8	66.68	51.9	69.85	34.93	12.7
2.125	53.9	71.42	55.0	76.20	42.85	14.3
2.250	57.1	72.21	58.2	79.38	34.93	14.3
2.375	60.3	76.20	61.4	82.55	42.85	14.3
2.500	63.5	79.38	64.6	85.73	34.93	14.3
2.625	66.6	82.55	67.7	85.73	42.85	15.9
2.750	69.8	85.73	70.9	88.90	42.85	15.9
2.875	73.0	88.90	74.1	95.25	42.85	15.9
3.000	76.2	92.08	77.3	98.43	42.85	15.9
3.125	79.3	95.25	80.5	101.60	42.85	19.8
3.250	82.5	98.43	83.6	104.78	42.85	19.8
3.375	85.7	101.60	86.8	107.95	42.85	19.8
3.500	88.9	104.78	90.0	111.13	42.85	19.8
3.625	92.0	107.95	93.1	114.30	42.85	19.8
3.750	95.2	111.13	96.3	117.48	42.85	19.8
3.875	98.4	114.30	99.5	120.65	42.85	19.8
4.000	101.6	117.48	102.7	123.83	42.85	19.8

TB8B1

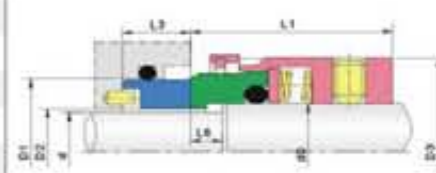

STOCK MATERIALS AND FACE MATERIAL CODE	
Rotary Face	Stationary Face
CAR	SIC
SIC	SIC
Elastomers: VIT, EPDM, NBR	

规格/Size (英制/Inch)	d0	d	D3	D2	D1	L1	L3	L6
1.000	25.4	22.2	39.67	24.0	38.30	33.32	10.31	8.00
1.125	28.5	25.4	42.85	27.5	41.48	34.93	11.10	7.90
1.250	31.7	28.5	47.63	30.5	44.65	34.93	11.10	7.90
1.375	34.9	31.7	50.80	33.5	47.83	36.50	11.10	8.70
1.500	38.1	34.9	53.98	37.0	51.00	36.50	11.10	8.70
1.625	41.2	38.1	60.33	40.0	54.18	44.45	11.10	8.70
1.750	44.4	41.2	63.50	43.5	60.53	44.45	12.70	9.50
1.875	47.6	44.4	66.68	46.5	63.70	44.45	12.70	9.50
2.000	50.8	47.6	69.85	49.5	66.88	44.45	12.70	9.50
2.125	53.9	50.8	76.20	53.0	70.05	52.37	12.70	11.10
2.250	57.1	53.9	79.38	56.0	76.40	52.37	14.27	11.10
2.375	60.3	57.1	82.55	59.0	79.58	52.37	14.27	11.10
2.500	63.5	60.3	85.73	62.5	82.75	52.37	14.27	11.10
2.625	66.6	63.5	88.90	65.5	85.93	52.37	14.27	11.10
2.750	69.8	66.6	92.08	68.5	85.93	52.37	15.88	11.10
2.875	73.0	69.8	95.25	72.0	89.10	52.37	15.88	11.10
3.000	76.2	73.0	96.82	75.0	95.45	52.37	15.88	11.10
3.125	79.3	76.2	100.00	78.5	98.63	52.37	15.88	11.10
3.250	82.5	79.3	104.78	81.5	101.80	52.37	19.84	14.30
3.375	85.7	82.5	107.95	84.5	104.98	52.37	19.84	14.30
3.500	88.9	85.7	111.13	88.0	108.15	52.37	19.84	14.30
3.625	92.0	88.9	114.30	91.0	111.33	52.37	19.84	14.30
3.750	95.2	92.0	117.48	94.0	114.50	52.37	19.84	14.30
3.875	98.4	95.2	120.65	97.5	117.68	52.37	19.84	14.30
4.000	101.6	98.4	123.83	100.5	120.85	52.37	19.84	14.30

TB8BT

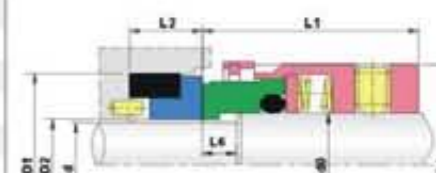

STOCK MATERIALS AND FACE MATERIAL CODE	
Rotary Face	Stationary Face
CAR	SIC
SIC	SIC
Elastomers: PTFE	

规格/Size (英制/Inch)	d0	d	D3	D2	D1	L1	L2	L6
1.000	25.4	22.2	36.50	22.9	38.10	33.32	10.3	8.7
1.125	28.5	25.4	39.67	26.1	41.28	34.93	11.1	8.7
1.250	31.7	28.5	42.85	29.3	44.45	34.93	11.1	8.7
1.375	34.9	31.7	49.20	29.3	44.45	42.85	11.1	8.7
1.500	38.1	31.7	49.20	32.4	47.63	36.50	11.1	8.7
1.625	41.2	34.9	57.15	35.6	50.80	40.46	11.1	11.1
1.750	44.4	38.1	58.72	38.8	53.96	44.45	11.1	11.1
1.875	47.6	41.2	63.50	42.4	60.33	44.45	12.7	11.1
2.000	50.8	44.4	66.68	45.5	63.50	44.45	12.7	11.1
2.125	53.9	47.6	71.42	48.7	66.68	52.37	12.7	12.7
2.250	57.1	50.8	72.21	51.9	69.85	44.45	12.7	12.7
2.375	60.3	53.9	76.20	55.0	76.20	52.37	14.3	12.7
2.500	63.5	57.1	79.38	58.2	79.38	44.45	14.3	12.7
2.625	66.6	60.3	82.55	61.4	82.55	52.37	14.3	12.7
2.750	69.8	63.5	85.73	64.6	85.73	52.37	14.3	12.7
2.875	73.0	66.6	88.90	67.7	85.79	52.37	15.9	12.7
3.000	76.2	69.8	92.08	70.9	88.90	52.37	15.9	12.7
3.125	79.3	73.0	95.25	74.1	95.25	52.37	15.9	14.3
3.250	82.5	76.2	98.43	77.3	98.43	52.37	15.9	14.3
3.375	85.7	79.3	101.60	80.5	101.60	52.37	19.8	14.3
3.500	88.9	82.5	104.78	83.6	104.78	52.37	19.8	14.3
3.625	92.0	85.7	107.95	86.8	107.95	52.37	19.8	14.3
3.750	95.2	88.9	111.13	90.0	111.13	52.37	19.8	14.3
3.875	98.4	92.0	114.30	93.1	114.30	52.37	19.8	14.3
4.000	101.6	95.2	117.48	96.3	117.48	52.37	19.8	14.3



TB40

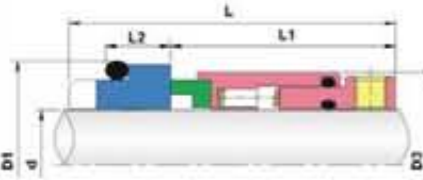

STOCK MATERIALS AND FACE MATERIAL CODE	
Rotary Face	Stationary Face
CAR	SIC
SIC	SIC
Elastomers: VIT, EPDM, NBR	

规格/Size (公制/Metric)	规格/Size (英寸/Inch)	D3	D1	L	L1	L12
18		32.5	33	40.0	30.0	10.0
19	0.750	33.5	35	40.0	30.0	10.0
20		34.5	35	40.0	30.0	10.0
22	0.875	36.5	37	40.0	30.0	10.0
24		38.5	39	40.0	30.0	10.0
25		39.5	40	40.0	30.0	10.0
	1.000	39.5	43	40.0	30.0	10.0
28		42.5	43	42.5	32.5	10.0
	1.125	42.5	45	42.5	32.5	10.0
30		44.5	45	42.5	32.5	10.0
32	1.250	46.0	48	42.5	32.5	10.0
33		47.0	48	42.5	32.5	10.0
35	1.375	48.0	50	42.5	32.5	10.0
38	1.500	52.0	56	45.0	34.0	11.0
40		56.0	58	45.0	34.0	11.0
42	1.625	56.0	61	45.0	34.0	11.0
43		59.0	61	45.0	34.0	11.0
44-45	1.750	59.0	63	45.0	34.0	11.0
48	1.875	62.4	66	45.0	34.0	11.0
50	2.000	65.6	70	47.5	34.0	13.0
53	2.125	68.8	73	47.5	34.5	13.0
55		70.8	75	47.5	34.5	13.0
	2.250	71.9	78	47.5	34.5	13.0
58		75.2	78	47.5	34.5	13.0
60	2.375	75.2	80	47.5	34.5	13.0
63		78.3	83	47.5	34.5	13.0
	2.500	78.3	85	47.5	34.5	13.0
65		84.2	85	49.0	36.5	13.0
68	2.625	85.5	90	51.3	36.5	15.3
70	2.750	87.4	92	51.3	36.5	15.3
73	2.875	90.6	97	51.3	36.5	15.3
75		92.7	97	51.3	36.5	15.3
	3.000	93.7	105	51.7	36.5	15.7
80	3.125	100.0	105	51.7	36.5	15.7
	3.250	100.0	110	51.7	36.5	15.7
85	3.375	103.3	110	51.7	36.5	15.7

TB58B

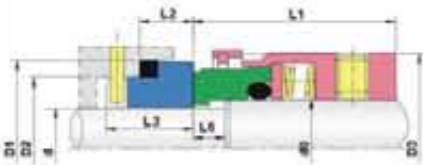

STOCK MATERIALS AND FACE MATERIAL CODE	
Rotary Face	Stationary Face
CAR	SIC
SIC	SIC
Elastomers: PTFE	

规格/Size (公制/Metric)	d	d0	D3	D2	D1	L1	L2	L3	L6
14	14	18	32	21	25	30.5	12.0	18.5	6.0
16	16	20	34	23	27	30.5	12.0	18.5	6.0
18	18	22	36	27	33	31.5	13.5	20.5	6.5
20	20	24	38	29	35	31.5	13.5	20.5	6.5
22	22	26	40	31	37	31.5	13.5	20.5	6.5
24	24	28	42	33	39	34.2	13.3	20.3	6.7
25	25	30	44	34	40	34.5	13.0	20.0	7.0
28	28	33	47	37	43	37.5	12.5	19.5	7.5
30	30	35	49	39	45	38.0	12.0	19.0	8.0
32	32	38	54	42	48	38.0	12.0	19.0	8.0
33	33	38	54	42	48	38.0	12.0	19.0	8.0
35	35	40	56	44	50	38.0	12.0	19.0	8.0
38	38	43	59	49	56	39.5	13.0	20.0	10.0
40	40	45	61	51	58	39.5	13.0	20.0	10.0
43	43	48	64	54	61	39.5	13.0	20.0	10.0
45	45	50	66	56	63	39.5	13.0	20.0	10.0
48	48	53	69	59	66	39.5	13.0	20.0	10.0
50	50	55	71	62	70	44.0	13.5	20.5	11.5
53	53	58	78	65	73	44.0	13.5	20.5	11.5
55	55	60	80	67	75	44.0	13.5	20.5	11.5
58	58	63	83	70	78	49.0	13.5	20.5	11.5
60	60	65	85	72	80	49.0	13.5	20.5	11.5
63	63	68	88	75	83	49.0	13.5	20.5	11.5
65	65	70	90	77	85	49.0	13.5	20.5	11.5
70	70	75	95	83	92	55.5	14.5	21.5	13.5
75	75	80	104	88	97	55.5	14.5	21.5	13.5
80	80	85	109	95	105	55.5	15.0	22.0	13.0
85	85	90	114	100	110	60.0	15.0	22.0	13.0
90	90	95	119	105	115	60.0	15.0	22.0	13.0
95	95	100	124	110	120	60.0	15.0	22.0	13.0
100	100	105	129	115	125	60.0	15.0	22.0	13.0

TB58U

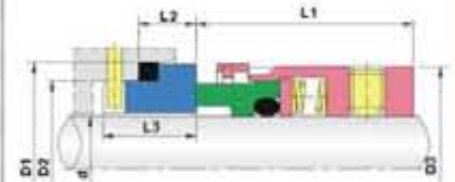

STOCK MATERIALS AND FACE MATERIAL CODE	
Rotary Face	Stationary Face
CAR	SIC
SIC	SIC
Elastomers: PTFE	

规格/Size (公制/Metric)	d	D3	D2	D1	L1	L2	L3
14	14	24	21	25	23.0	12.0	18.5
16	16	26	23	27	23.0	12.0	18.5
18	18	32	27	33	24.0	13.5	20.5
20	20	34	29	35	24.0	13.5	20.5
22	22	36	31	37	24.0	13.5	20.5
24	24	38	33	39	26.5	13.5	20.3
25	25	39	34	40	27.0	13.0	20.0
28	28	42	37	43	30.0	12.5	19.5
30	30	44	39	45	30.5	12.0	19.0
32	32	46	42	48	30.5	12.0	19.0
33	33	47	42	48	30.5	12.0	19.0
35	35	49	44	50	30.5	12.0	19.0
38	38	54	49	56	32.0	13.0	20.0
40	40	56	51	58	32.0	13.0	20.0
43	43	59	54	61	32.0	13.0	20.0
45	45	61	56	63	32.0	13.0	20.0
48	48	64	59	65	32.0	13.0	20.0
50	50	66	62	70	34.0	13.5	20.5
53	53	69	65	73	34.0	13.5	20.5
55	55	71	67	75	34.0	13.5	20.5
58	58	78	70	78	39.0	13.5	20.5
60	60	80	72	80	39.0	13.5	20.5
63	63	83	75	83	39.0	13.5	20.5
65	65	85	77	85	39.0	13.5	20.5
68	68	88	81	90	39.0	13.5	20.5
70	70	90	83	92	45.5	14.5	21.5
75	75	99	88	97	45.5	14.5	21.5
80	80	104	95	105	45.0	15.0	22.0
85	85	109	100	110	45.0	15.0	22.0
90	90	114	105	115	50.0	15.0	22.0
95	95	119	110	120	50.0	15.0	22.0
100	100	124	115	125	50.0	15.0	22.0

TB67

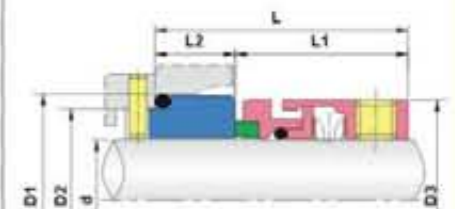

规格/Size (公制/Metric)	Code	D1	D2	D3	L1	L2	L
14	140	25.0	21.0	24.0	25.0	10.0	35.0
16	160	27.0	23.0	26.0	25.0	10.0	35.0
18	180	33.0	27.0	32.0	26.0	11.5	37.5
20	200	35.0	29.0	34.0	26.0	11.5	37.5
22	240	37.0	31.0	36.0	26.0	11.5	37.5
24	250	39.0	33.0	38.0	28.5	11.5	40.0
25	280	40.0	34.0	39.0	28.5	11.5	40.0
28	300	43.0	37.0	42.0	31.0	11.5	42.5
30	320	45.0	39.0	44.0	31.0	11.5	42.5
32	330	48.0	42.0	46.0	31.0	11.5	42.5
33	350	48.0	42.0	47.0	31.0	11.5	42.5
35	380	50.0	44.0	49.0	31.0	11.5	42.5
38	400	56.0	49.0	54.0	31.0	14.0	45.0
40	430	58.0	51.0	56.0	31.0	14.0	45.0
43	450	61.0	54.0	59.0	31.0	14.0	45.0
45	480	63.0	56.0	61.0	31.0	14.0	45.0
48	600	66.0	59.0	64.0	31.0	14.0	45.0
50	500	70.0	62.0	66.0	32.5	15.0	47.5
53	530	73.0	65.0	69.0	32.5	15.0	47.5
55	550	75.0	67.0	71.0	32.5	15.0	47.5
58	580	78.0	70.0	78.0	37.5	15.0	52.5
60	600	80.0	72.0	80.0	37.5	15.0	52.5
63	630	83.0	75.0	83.0	37.5	15.0	52.5
65	650	85.0	77.0	85.0	37.5	15.0	52.5
68	680	90.0	81.0	88.0	34.5	18.0	52.5
70	700	92.0	83.0	90.0	42.0	18.0	60.0
75	750	97.0	88.0	99.0	42.0	18.0	60.0
80	800	105.0	95.0	104.0	41.8	18.2	60.0
85	850	110.0	100.0	109.0	41.8	18.2	60.0
90	900	115.0	105.0	114.0	46.8	18.2	65.0
95	950	120.0	110.0	119.0	47.8	17.2	65.0
100	1000	125.0	115.0	124.0	47.8	17.2	65.0



TB68

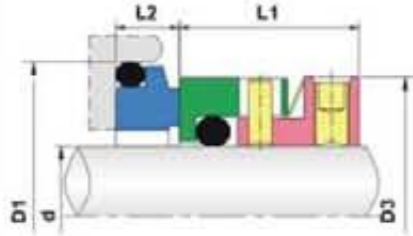

规格/Size (公制/Metric)	D1	D3	L1	L2
15.8	28.50	27.00	19.1	6.30
16.0	28.50	27.00	19.1	6.30
19.1	31.70	30.00	19.1	6.30
24.0	35.40	34.10	19.1	7.60
28.0	42.00	40.00	19.1	7.60
28.6	41.20	39.50	19.1	7.60
30.0	42.70	41.00	19.1	7.60
31.7	44.20	42.40	19.1	7.60
32.0	44.40	42.40	19.1	7.60
35.0	47.60	45.50	19.1	7.60
38.0	53.90	51.80	21.1	8.10
44.4	60.30	58.20	21.1	8.10
47.6	63.50	61.40	21.1	8.10
50.0	63.90	61.90	21.1	8.10
50.8	66.60	64.60	22.1	9.60
53.9	73.00	71.00	22.1	9.60
54.0	73.90	71.00	22.1	9.60
54.6	75.00	72.00	22.1	9.60
55.0	75.00	72.00	22.1	9.60
63.0	83.00	79.30	25.8	9.10
63.5	88.90	79.30	25.8	9.10
69.8	95.20	88.90	25.8	9.10
73.0	98.40	94.00	25.8	9.10
75.0	100.40	96.00	25.8	9.10

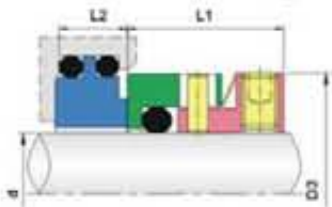

PUMP ref:	规格/Size (公制/Metric)	D3	L1	L2
10	30	41.0	19.1	10.3
20	35	45.5	19.1	12.0
30	50	61.9	21.1	12.0

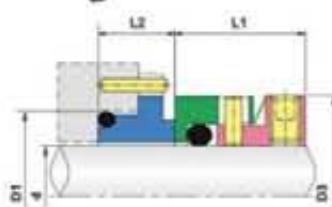

PUMP ref:	规格/Size (公制/Metric)	D1	D3	L1	L2
SR1	20	30.00	31.00	19.1	10.70
SR2	30	41.00	41.00	19.1	10.90
SR3	35	47.00	45.50	21.1	12.20
SR4	45	58.00	58.20	21.1	11.60
SR5	55	70.00	72.00	22.1	13.00
SR6	75	92.00	96.00	25.8	14.50

TB68C

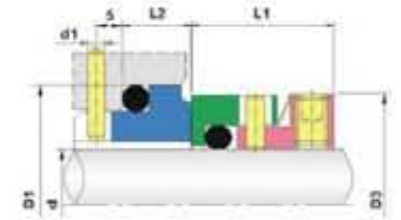

规格/Size (公制/Metric)	D1	D3	d1	L1	L2
16	27.00	27.0	4.00	19.10	8.60
20	35.00	31.0	5.00	19.10	10.00
22	37.00	33.0	5.00	19.10	10.00
24	39.00	34.1	5.00	19.10	10.00
25	40.00	35.2	5.00	19.10	10.00
28	43.00	40.0	5.00	19.10	10.00
30	45.00	41.0	5.00	19.10	10.00
32	48.00	42.4	5.00	19.10	10.00
33	48.00	44.0	5.00	19.10	10.00
35	50.00	45.5	5.00	19.10	10.00
38	56.00	51.8	5.00	21.10	11.00
40	58.00	53.8	5.00	21.10	11.00
43	61.00	56.0	5.00	21.10	11.00
45	63.00	58.2	5.00	21.10	11.00
48	66.00	61.4	5.00	21.10	11.00
50	70.00	61.9	5.00	21.10	13.00
55	75.00	72.0	5.00	22.10	13.00
60	80.00	76.0	5.00	25.80	13.00
63	83.00	79.3	5.00	25.80	13.00
65	85.00	82.3	5.00	25.80	13.00
70	92.00	88.9	5.00	25.80	15.30
75	97.00	96.0	5.00	25.80	15.30

TB68D

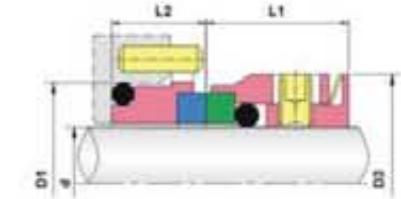

PUMP ref:	规格/Size (公制/Metric)	D1	D3	L1	L2
SR1	20	30.00	32.4	20.0	10.70
SR2	30	41.30	44.0	21.4	10.90
SR3	35	47.00	50.8	22.0	12.20
SR4	45	58.30	62.4	22.9	11.60
SR5	55	69.60	76.0	29.3	13.00
SR6	75	92.20	99.2	31.1	14.50

TB68E

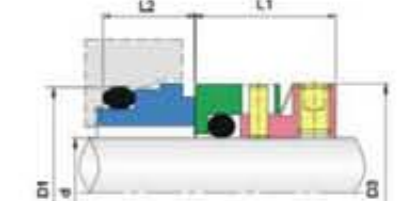

PUMP ref:	规格/Size (公制/Metric)	D1	D3	L1	L2
10	30	40.0	41.0	19.1	9.3
20	35	44.5	45.5	19.1	9.2
30	50	62.0	61.9	21.1	10.4
40	70	85.0	88.9	25.8	14.1
50	80	95.0	101.0	25.8	16.2



TB82

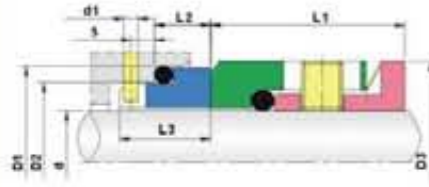

STOCK MATERIALS AND FACE MATERIAL CODE	
Rotary Face	Stationary Face
CAR	SIC
SIC	SIC
Elastomers: VIT, EPDM, NBR	

规格/Size (公制/Metric)	d	D3	D2	D1	d1	L1	L2	L3
16	16	26	23	27	3	19.1	8.6	15.0
18	18	29	27	33	3	19.1	10.0	17.0
20	20	32	29	35	3	19.1	10.0	17.0
22	22	35	31	37	3	19.1	10.0	17.0
24	24	37	33	39	3	19.1	10.0	17.0
25	25	37	34	40	3	19.1	10.0	17.0
28	28	41	37	43	3	19.1	10.0	17.0
30	30	43	39	45	3	19.1	10.0	17.0
32	32	47	42	48	3	19.1	10.0	17.0
33	33	48	42	48	3	19.1	10.0	17.0
35	35	49	44	50	3	19.1	10.0	17.0
38	38	53	49	56	4	21.1	11.0	18.0
40	40	55	51	58	4	21.1	11.0	18.0
43	43	60	54	61	4	21.1	11.0	18.0
45	45	60	56	63	4	21.1	11.0	18.0
48	48	65	59	66	4	21.1	11.0	18.0
50	50	65	62	70	4	21.1	13.0	20.0
53	53	74	65	73	4	22.1	13.0	20.0
55	55	74	67	75	4	22.1	13.0	20.0
58	58	79	70	78	4	25.8	13.0	20.0
60	60	79	72	80	4	25.8	13.0	20.0
63	63	87	75	83	4	25.8	13.0	20.0
65	65	87	77	85	4	25.8	13.0	20.0
68	68	93	81	90	4	25.8	15.3	22.0
70	70	93	83	92	4	25.8	15.3	22.0
75	75	98	88	97	4	25.8	15.3	22.0
80	80	104	95	105	4	25.8	15.7	22.5
85	85	108	100	110	4	25.8	15.7	22.5
90	90	113	105	115	4	25.8	15.7	22.5
95	95	118	110	120	4	25.8	15.7	22.5
100	100	123	115	125	4	25.8	15.7	22.5

TB92N

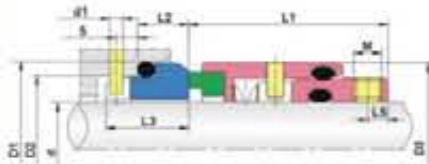

STOCK MATERIALS AND FACE MATERIAL CODE	
Rotary Face	Stationary Face
CAR	SIC
SIC	SIC
Elastomers: VIT, EPDM, NBR	

规格/Size (公制/Metric)	d	D3	D2	D1	d1	L1	L2	L3	L5	M
18	18	32	27	33	3	30.5	7.0	15.0	3.0	M4
20	20	34	29	35	3	30.5	7.0	15.0	3.0	M4
22	22	36	31	37	3	30.5	7.0	15.0	3.0	M4
24	24	38	33	39	3	33.0	7.0	15.0	3.5	M5
25	25	39	34	40	3	33.0	7.0	15.0	3.5	M5
28	28	42	37	43	3	35.5	7.0	15.0	3.5	M5
30	30	44	39	45	3	35.5	7.0	15.0	3.5	M5
32	32	47	42	48	3	35.5	7.0	15.0	3.5	M5
33	33	47	42	48	3	35.5	7.0	15.0	3.5	M5
35	35	49	44	50	3	35.5	7.0	15.0	3.5	M5
38	38	54	49	56	4	37.0	8.0	16.0	4.0	M5
40	40	56	51	58	4	37.0	8.0	16.0	4.0	M5
43	43	59	54	61	4	37.0	8.0	16.0	4.0	M5
45	45	61	56	63	4	37.0	8.0	16.0	4.0	M5
48	48	64	59	66	4	37.0	8.0	16.0	4.0	M5
50	50	66	62	70	4	38.0	9.5	17.0	4.5	M6
53	53	69	65	73	4	38.0	9.5	17.0	4.5	M6
55	55	71	67	75	4	38.0	9.5	17.0	4.5	M6
58	58	78	70	78	4	42.0	10.5	18.0	4.5	M6
60	60	80	72	80	4	42.0	10.5	18.0	4.5	M6
63	63	83	75	83	4	42.0	10.5	18.0	4.5	M6
65	65	85	77	85	4	42.0	10.5	18.0	4.5	M6
68	68	88	81	90	4	41.5	11.0	18.5	4.5	M6
70	70	90	83	92	4	48.5	11.5	19.0	5.0	M6
75	75	99	88	97	4	48.5	11.5	19.0	5.5	M8
80	80	104	95	105	4	48.5	11.5	19.0	5.5	M8
85	85	109	100	110	4	48.5	11.5	19.0	5.5	M8
90	90	114	105	115	4	52.0	13.0	20.5	5.5	M8
95	95	119	110	120	4	52.0	13.0	20.5	5.5	M8
100	100	124	115	125	4	52.0	13.0	20.5	5.5	M8

TB491

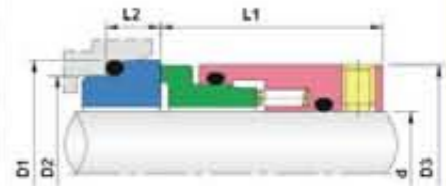

STOCK MATERIALS AND FACE MATERIAL CODE	
Rotary Face	Stationary Face
CAR	SIC
SIC	SIC
Elastomers: VIT, EPDM, NBR	

规格/Size (公制/Metric)	d	D1	D2	D3	L1	L2
18	18	33	27	32.28	30	7.5
20	20	35	29	34.29	30	7.5
22	22	37	31	36.30	30	7.5
24	24	39	33	38.30	30	7.5
25	25	40	34	39.29	30	7.5
28	28	43	37	42.29	35	7.5
30	30	45	39	44.30	35	7.5
32	32	48	42	46.30	35	7.5
33	33	48	42	47.90	35	7.5
35	35	50	44	49.48	35	7.5
38	38	56	49	54.28	35	9
40	40	58	51	56.08	35	9
43	43	61	54	59.08	35	9
45	45	63	56	61.09	35	9
48	48	66	59	64.11	35	9
50	50	70	62	66.09	35	9.5
53	53	73	65	71.00	35	11
55	55	75	67	71.07	35	11
60	60	80	72	77.14	35	11
65	65	85	77	83.01	35	11
68	68	90	81	91.00	35	11.3
70	70	92	83	86.08	35	11.3
75	75	97	88	98.43	48	11.3
80	80	105	95	104.79	48	12
85	85	110	100	107.95	48	12
90	90	115	105	114.30	48	14
100	100	125	115	123.83	48	14

TB591

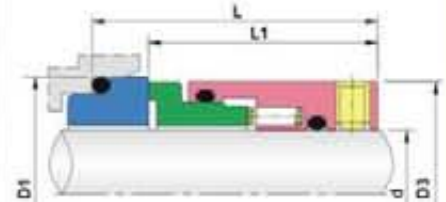

STOCK MATERIALS AND FACE MATERIAL CODE	
Rotary Face	Stationary Face
CAR	SIC
SIC	SIC
Elastomers: VIT, EPDM, NBR	

规格/Size (公制/Metric)	D3	D1 DIN	D1 STAND	L DIN	L STAND	L1
16	32.00	27.0	28.00	27.50	28.00	20.5
18	34.00	33.0	30.00	39.50	28.00	20.5
19	35.00	35.0	35.00	30.00	30.00	22.5
20	36.00	35.0	35.00	30.00	30.00	22.5
22	38.00	37.0	35.00	31.00	30.00	22.5
24	40.00	39.0	38.00	30.50	30.00	22.5
25	42.00	40.0	38.00	31.00	30.00	22.5
28	45.00	43.0	42.00	30.50	30.00	22.5
30	47.00	45.0	45.00	30.00	30.00	22.5
32	49.00	48.0	48.00	30.00	30.00	22.5
33	50.00	48.0	48.00	30.00	30.00	22.5
35	52.00	50.0	52.00	30.50	31.50	22.5
38	55.00	56.0	55.00	31.00	30.50	22.5
40	47.00	58.0	58.00	30.50	30.50	22.5
43	60.00	61.0	61.00	37.50	37.50	28.5
45	62.00	63.0	64.00	37.50	38.00	28.5
48	65.00	66.0	66.00	37.50	38.80	28.5
50	67.00	70.0	69.30	38.80	39.00	28.5
53	70.00	73.0	73.00	38.00	38.00	28.5
55	72.00	75.0	75.40	38.50	38.80	28.5
60	77.00	80.0	80.40	39.50	39.50	28.5
65	82.00	85.0	85.40	39.50	39.50	28.5
70	87.00	92.0	92.00	41.50	41.50	30.5
75	93.00	97.0	99.00	43.50	44.50	30.5
80	98.00	105.0	104.00	44.00	43.50	30.5
85	103.00	110.0	109.00	44.00	43.50	30.5
90	108.00	115.0	114.00	44.00	43.50	30.5
95	113.00	120.0	120.30	44.00	44.00	30.5
100	118.00	125.0	123.30	44.00	44.00	30.5



TB891

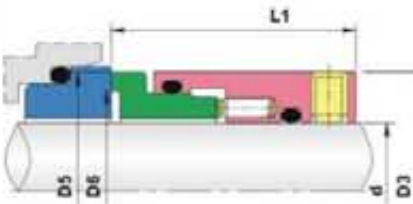

STOCK MATERIALS AND FACE MATERIAL CODE

Rotary Face	Stationary Face
CAR	SIC
SIC	SIC

Elastomers: VIT, EPDM, NBR

规格/Size (公制/Metric)	d	D5	D6	D3	L1
25	25	37.5	32.5	39.3	34.9
28	28	40	35	42.3	34.9
30	30	42	37	44.5	34.9
32	32	44.5	39	46.0	44.4
33	33	45.5	40	47.5	44.4
35	35	47.5	42	49.0	44.4
38	38	50.5	45	52.5	44.4
40	40	53	47	55.6	44.4
42	42	56	50	58.7	44.4
43	43	56	50	58.7	44.4
45	45	58	52	60.3	44.4
48	48	61	55	63.5	44.4
50	50	63.6	57.6	66.7	44.4
53	53	67.8	61.8	69.8	44.4
55	55	67.8	61.8	69.8	44.4
58	58	70.8	64.8	73.0	44.4
60	60	73.5	67.5	76.2	44.4
63	63	76.5	70.5	79.4	44.4
65	65	79.5	73.5	82.6	44.4
70	70	83.4	76.9	85.7	44.4
75	75	90.4	83.9	96.8	44.4
80	80	94.2	87.7	100.0	44.4
85	85	100.3	93.3	106.4	44.4
90	90	104.9	97.4	109.5	44.4
95	95	110.5	102.5	115.9	44.4
100	100	116.9	108.9	122.2	44.4

规格/Size (英寸/Inch)	d	D5	D6	D3
1.000	25.4	37.5	32.5	39.3
1.125	28.5	40	35	42.3
1.250	31.7	44.5	39	46
1.375	34.9	47.5	42	49
1.500	38.1	50.5	45	52.5
1.625	41.2	55	49	57.2
1.750	44.4	56	52	60.3
1.875	47.6	61	55	63.5
2.000	50.8	63.6	57.6	66.7
2.125	53.9	67.8	61.8	69.8
2.250	57.1	70.8	64.8	73
2.375	60.3	73.5	67.5	76.2
2.500	63.5	76.5	70.5	79.4
2.625	66.6	79.5	73.5	82.6
2.750	69.8	86.4	76.9	85.7
2.875	73.0	88.4	79.9	88.9
3.000	76.2	90.4	83.9	96.8
3.125	79.3	94.2	87.7	100
3.250	82.5	97.3	90.3	103.2
3.375	85.7	100.3	93.3	106.4
3.500	88.9	104.9	97.4	109.5
3.625	92.0	106.9	99.4	112.7
3.750	95.2	110.5	102.5	115.9
3.875	98.4	113.7	105.7	119
4.000	101.6	116.9	108.9	122.2

TBRO-A

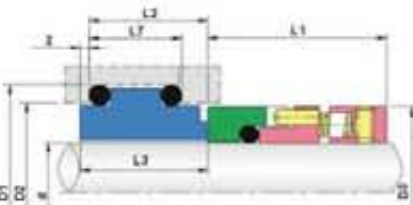

STOCK MATERIALS AND FACE MATERIAL CODE

Rotary Face	Stationary Face
CAR	SIC
SIC	SIC

Elastomers: VIT, EPDM, NBR

规格/Size (公制/Metric)	d	D3	D2	D1	L7	L1	L2	L3
20	20	34	36	42	18	35	23	25
22	22	36	38	44	18	35	23	25
24	24	38	40	46	18	35	23	25
25	25	39	41	47	18	35	23	25
28	28	42	44	50	18	35	23	25
30	30	44	46	52	18	35	23	25
32	32	46	48	54	18	35	23	25
33	33	47	49	55	18	35	23	25
35	35	49	51	57	18	35	23	25
38	38	54	58	64	20	38	25	27
40	40	56	60	66	20	38	25	27
42	42	58	62	68	20	38	25	27
43	43	59	63	69	20	38	25	27
45	45	61	65	71	20	38	25	27
48	48	64	68	74	20	38	25	27
50	50	66	70	76	20	39	25	27
52	52	68	72	78	20	40	25	27
53	53	69	73	79	20	40	25	27
55	55	71	75	81	20	40	25	27
58	58	76	83	89	22	41	28	30
60	60	78	85	91	22	41	28	30
62	62	80	87	93	22	41	28	30
63	63	81	88	94	22	41	28	30
65	65	83	90	96	22	41	28	30
68	68	86	93	99	24	41	30	32
70	70	90	95	101	24	42	30	32
75	75	95	104	110	24	42	30	32
80	80	100	109	115	25	42	31	33
85	85	105	114	120	25	43	31	33
90	90	110	119	125	25	45	31	33
95	95	115	124	130	25	45	31	33
100	100	120	129	135	25	45	31	33

规格/Size (公制/Metric)	d	D3	D2	D1	d1	L1	L2	L3
20	20	34	29	35	3	35	13	21
22	22	36	31	37	3	35	13	21
24	24	38	33	39	3	35	13	21
25	25	39	34	40	3	35	13	21
28	28	42	37	43	3	35	13	21
30	30	44	39	45	3	35	13	21
32	32	46	42	48	3	35	13	21
33	33	47	42	48	3	35	13	21
35	35	49	44	50	3	35	13	21
38	38	54	50	56	4	38	13	21
40	40	56	52	58	4	38	13	21
43	43	59	55	61	4	38	13	21
45	45	61	57	63	4	38	13	21
48	48	64	60	66	4	38	13	21
50	50	66	62	68	4	39	13	21
53	53	69	65	71	4	40	13	21
55	55	71	67	73	4	40	13	21
58	58	76	70	79	4	41	16	24
60	60	78	72	81	4	41	16	24
63	63	81	75	84	4	41	16	24
65	65	83	77	86	4	41	16	24
68	68	86	81	90	4	41	16	24
70	70	90	83	92	4	42	16	24
75	75	95	88	97	4	42	16	24
80	80	100	96	105	4	42	16	24
85	85	105	101	110	4	43	16	24
90	90	110	106	115	4	45	16	24
95	95	115	111	120	4	45	16	24
100	100	120	116	125	4	45	16	24

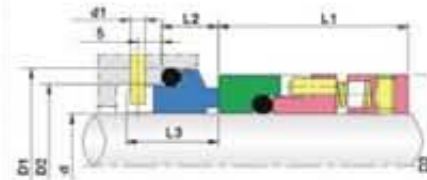

STOCK MATERIALS AND FACE MATERIAL CODE

Rotary Face	Stationary Face
CAR	SIC
SIC	SIC

Elastomers: VIT, EPDM, NBR

规格/Size (公制/Metric)	D3	D2	D1	d1	L0	L	L1
20	34	29	35	3	51	44	31
22	36	31	37	3	51	44	31
24	38	33	39	3	51	44	31
25	39	34	40	3	51	44	31
28	42	37	43	3	53	46	33
30	44	39	45	3	53	46	33
32	46	42	48	3	56	49	36
33	47	42	48	3	56	49	36
35	49	44	50	3	56	49	36
38	54	49	58	4	62	55	40
40	56	51	58	4	62	55	40
43	59	54	61	4	64	57	42
45	61	56	63	4	64	57	42
48	64	59	66	4	64	57	42
50	66	62	70	4	65	58	42
53	69	65	73	4	65	58	42
55	71	67	75	4	65	58	42
58	78	70	78	4	66	59	43
60	80	72	80	4	66	59	43
63	83	75	83	4	66	59	43
65	85	77	85	4	66	59	43
68	88	81	90	4	68	61	43
70	90	83	92	4	69	62	44
75	99	88	97	4	69	62	44
80	104	95	105	4	74	67	49
85	109	100	110	4	74	67	49
90	114	105	115	4	74	67	49
95	119	110	120	4	74	67	49
100	124	115	125	4	74	67	49
105	129	120	130	4	74	67	49
110	138	125	136	4	74	67	49
115	143	130	141	4	74	67	49
120	148	135	146	4	74	67	49

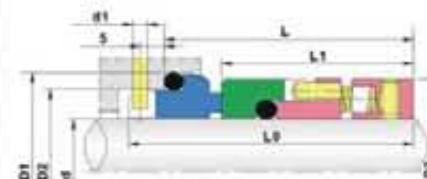

STOCK MATERIALS AND FACE MATERIAL CODE

Rotary Face	Stationary Face
CAR	SIC
SIC	SIC

Elastomers: VIT, EPDM, NBR



TBMTN

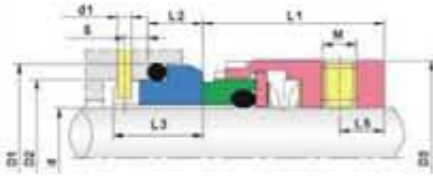

STOCK MATERIALS AND FACE MATERIAL CODE

Rotary Face	Stationary Face
CAR	SIC
SIC	SIC

Elastomers: VIT , EPDM , NBR

规格/Size (公制/Metric)	d	D3	D2	D1	d1	L1	L2	L3	L5	M
14	14	25	21	25	3	25.0	10.0	17.5	6	M5
16	16	27	23	27	3	25.0	10.0	17.5	6	M5
18	18	33	27	33	3	26.0	11.5	19.5	7	M5
20	20	35	29	35	3	26.0	11.5	19.5	7	M5
22	22	37	31	37	3	26.0	11.5	19.5	7	M5
24	24	39	33	39	3	28.5	11.5	19.5	8	M5
25	25	40	34	40	3	28.5	11.5	19.5	8	M5
28	28	43	37	43	3	31.0	11.5	19.5	8	M6
30	30	45	39	45	3	31.0	11.5	19.5	8	M6
32	32	47	42	48	3	31.0	11.5	19.5	8	M6
33	33	48	42	48	3	31.0	11.5	19.5	8	M6
35	35	50	44	50	3	31.0	11.5	19.5	8	M6
38	38	55	49	56	4	31.0	14.0	22.0	8	M6
40	40	57	51	58	4	31.0	14.0	22.0	8	M6
43	43	60	54	61	4	31.0	14.0	22.0	8	M6
45	45	62	56	63	4	31.0	14.0	22.0	8	M6
48	48	65	59	66	4	31.0	14.0	22.0	8	M6
50	50	67	62	70	4	32.5	15.0	23.0	8	M6
53	53	70	65	73	4	32.5	15.0	23.0	8	M6
55	55	72	67	75	4	32.5	15.0	23.0	8	M6
58	58	79	70	78	4	37.5	15.0	23.0	9	M8
60	60	81	72	80	4	37.5	15.0	23.0	9	M8
63	63	84	75	83	4	37.5	15.0	23.0	9	M8
65	65	86	77	85	4	37.5	15.0	23.0	9	M8
68	68	89	81	90	4	34.5	18.0	26.0	9	M8
70	70	91	83	92	4	42.0	18.0	26.0	9	M8
75	75	99	88	97	4	42.0	18.0	26.0	10	M8
80	80	104	95	105	4	41.8	18.2	26.2	10	M8
85	85	109	100	110	4	41.8	18.2	26.2	10	M8
90	90	114	105	115	4	46.8	18.2	26.2	10	M8
95	95	119	110	120	4	47.8	17.2	25.2	10	M8
100	100	124	115	125	4	47.8	17.2	25.2	10	M8

TBHTN

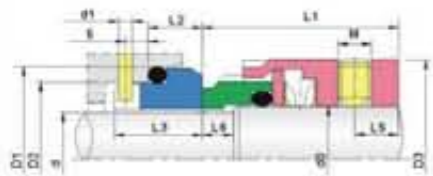

STOCK MATERIALS AND FACE MATERIAL CODE

Rotary Face	Stationary Face
CAR	SIC
SIC	SIC

Elastomers: VIT , EPDM , NBR

规格/Size (公制/Metric)	d0	d	D3	D2	D1	d1	L1	L2	L3	L6	L5	M
14	18	14	33	21	25	3	32.5	10.0	17.5	8.0	6	M5
16	20	16	35	23	27	3	32.5	10.0	17.5	8.0	6	M5
18	22	18	37	27	33	3	33.5	11.5	19.5	8.5	7	M5
20	24	20	39	29	35	3	33.5	11.5	19.5	8.5	5.5	M5
22	26	22	41	31	37	3	33.5	11.5	19.5	8.5	8	M5
24	28	24	43	33	39	3	36.0	11.5	19.5	8.5	5.5	M6
25	30	25	45	34	40	3	36.0	11.5	19.5	8.5	5.5	M6
28	33	28	48	37	43	3	38.5	11.5	19.5	8.5	8	M6
30	35	30	50	39	45	3	38.5	11.5	19.5	8.5	8	M6
32	38	32	55	42	48	3	38.5	11.5	19.5	8.5	8	M6
33	38	33	55	42	48	3	38.5	11.5	19.5	8.5	8	M6
35	40	35	57	44	50	3	38.5	11.5	19.5	8.5	8	M6
38	43	38	60	49	56	4	38.5	14.0	22.0	9.0	8	M6
40	45	40	62	51	58	4	38.5	14.0	22.0	9.0	8	M6
43	48	43	65	54	61	4	38.5	14.0	22.0	9.0	8	M6
45	50	45	67	56	63	4	38.5	14.0	22.0	9.0	8	M6
48	53	48	70	59	66	4	38.5	14.0	22.0	9.0	8	M6
50	55	50	72	62	70	4	42.5	15.0	23.0	10.0	8	M6
53	58	53	79	65	73	4	42.5	15.0	23.0	10.0	9	M8
55	60	55	81	67	75	4	42.5	15.0	23.0	10.0	9	M8
58	63	58	84	70	78	4	47.5	15.0	23.0	10.0	9	M8
60	65	60	86	72	80	4	47.5	15.0	23.0	10.0	9	M8
63	68	63	89	75	83	4	47.5	15.0	23.0	10.0	9	M8
65	70	65	91	77	85	4	47.5	15.0	23.0	10.0	9	M8
70	75	70	99	83	92	4	52.0	18.0	26.0	10.0	10	M8
75	80	75	104	88	97	4	52.0	18.0	26.0	10.0	10	M8
80	85	80	109	95	105	4	51.8	18.2	26.2	9.8	10	M8
85	90	85	114	100	110	4	56.8	18.2	26.2	9.8	10	M8
90	95	90	119	105	115	4	56.8	18.2	26.2	9.8	10	M8
95	100	95	124	110	120	4	57.8	17.2	25.2	10.8	10	M8
100	105	100	129	115	125	4	57.8	17.2	25.2	10.8	10	M8

TBM74A

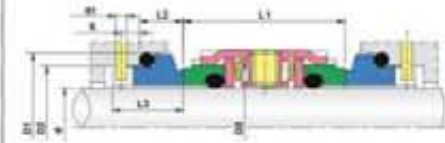

STOCK MATERIALS AND FACE MATERIAL CODE

Rotary Face	Stationary Face
CAR	SIC
SIC	SIC

Elastomers: VIT , EPDM , NBR

规格/Size (公制/Metric)	d	D2	D1	D3	d1	L1	L2	L3
18	18	27	33	33	3	38	11.5	19.5
20	20	29	35	35	3	38	11.5	19.5
22	22	31	37	37	3	38	11.5	19.5
24	24	33	39	39	3	38	11.5	19.5
25	25	34	40	40	3	38	11.5	19.5
28	28	37	43	43	3	39	11.5	19.5
30	30	39	45	45	3	39	11.5	19.5
32	32	42	48	47	3	39	11.5	19.5
33	33	42	48	48	3	39	11.5	19.5
35	35	44	50	50	3	39	11.5	19.5
38	38	49	56	55	4	41	14.0	22.0
40	40	51	58	57	4	42	14.0	22.0
43	43	54	61	60	4	42	14.0	22.0
45	45	56	63	62	4	42	14.0	22.0
48	48	59	66	65	4	42	14.0	22.0
50	50	62	70	67	4	43	15.0	23.0
53	53	65	73	70	4	43	15.0	23.0
55	55	67	75	72	4	43	15.0	23.0
58	58	70	78	79	4	56	15.0	23.0
60	60	72	80	81	4	56	15.0	23.0
63	63	75	83	84	4	55	15.0	23.0
65	65	77	85	86	4	55	15.0	23.0
68	68	81	90	89	4	55	18.0	26.0
70	70	83	92	91	4	56	18.0	26.0
75	75	88	97	99	4	56	18.0	26.0
80	80	95	105	104	4	56	18.2	26.2
85	85	100	110	109	4	56	18.2	26.2
90	90	105	115	114	4	56	18.2	26.2
95	95	110	120	119	4	56	17.2	25.2
100	100	115	125	124	4	56	17.2	25.2

TBM74D

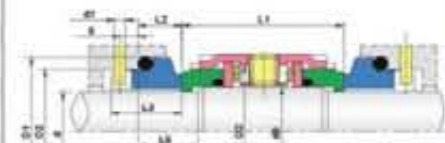

STOCK MATERIALS AND FACE MATERIAL CODE

Rotary Face	Stationary Face
CAR	SIC
SIC	SIC

Elastomers: VIT , EPDM , NBR

规格/Size (公制/Metric)	d	d0	D3	D2	D1	d1	L6	L1	L2	L3
14	14	18	33	21	25	3	18	53.0	10.0	17.5
16	16	20	35	23	27	3	18	53.0	10.0	17.5
18	18	22	37	27	33	3	20	53.0	11.5	19.5
20	20	24	39	29	35	3	20	53.0	11.5	19.5
22	22	26	41	31	37	3	20	53.0	11.5	19.5
24	24	28	43	33	39	3	20	54.0	11.5	19.5
25	25	30	45	34	40	3	20	54.0	11.5	19.5
28	28	33	48	37	43	3	20	54.0	11.5	19.5
30	30	35	50	39	45	3	20	54.0	11.5	19.5
32	32	38	55	42	48	3	20	56.0	11.5	19.5
33	33	38	55	42	48	3	20	56.0	11.5	19.5
35	35	40	57	44	50	3	20	57.0	11.5	19.5
38	38	43	60	49	58	4	23	57.0	14.0	22.0
40	40	45	62	51	58	4	23	57.0	14.0	22.0
43	43	48	65	54	61	4	23	57.0	14.0	22.0
45	45	50	67	56	63	4	23	56.0	14.0	22.0
48	48	53	70	59	65	4	23	56.0	14.0	22.0
50	50	55	72	62	70	4	25	63.0	15.0	23.0
53	53	58	79	65	73	4	25	67.0	15.0	23.0
55	55	60	81	67	75	4	25	67.0	15.0	23.0
58	58	63	84	70	78	4	25	74.0	15.0	23.0
60	60	65	86	72	80	4	25	74.0	15.0	23.0
63	63	68	89	75	83	4	25	79.0	15.0	23.0
65	65	70	91	77	85	4	25	68.0	15.0	23.0
70	70	75	99	83	92	4	28	76.4	18.0	



TB1

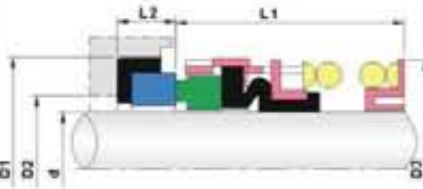

STOCK MATERIALS AND FACE MATERIAL CODE	
Rotary Face	Stationary Face
CAR	CER
CAR	SIC
SIC	SIC

Elastomers: VIT, EPDM, NBR

规格/Size (英寸/Inch)	规格/Size (公制/Metric)	D1	D2	D3	L1	L2
0.500	12	25.40	19.05	23.80	30.16	7.93
	14	31.75	23.80	27.76	33.32	10.28
0.625	16	31.75	23.80	27.76	33.32	10.28
0.750	18	34.93	26.98	30.94	33.32	10.28
	20	38.10	30.15	34.11	34.93	10.28
0.875	22	38.10	30.15	34.11	34.93	10.28
	24	41.28	33.32	38.10	39.67	11.10
1.000	25	41.28	33.32	38.10	39.67	11.10
1.125	28	44.44	36.50	41.28	41.28	11.10
	30	47.63	37.90	46.02	41.28	11.10
1.250	32	47.63	37.90	46.02	41.28	11.10
	33	50.80	42.84	48.68	42.85	11.10
1.375	35	50.80	42.84	48.68	42.85	11.10
1.500	38	53.98	46.05	51.85	42.85	11.10
1.625	40	60.38	50.80	58.10	50.80	12.70
	43	63.50	53.97	61.27	50.80	12.70
1.750	45	63.50	53.97	61.27	50.80	12.70
1.875	48	66.68	57.15	64.44	53.98	12.70
	48	69.85	60.32	67.21	53.98	12.70
2.000	50	69.85	60.32	67.21	53.98	12.70
2.125	53	76.20	60.32	72.02	60.33	14.28
2.250	55	79.38	61.09	75.30	60.33	14.28
2.375	60	82.55	67.39	78.30	63.50	14.28
2.500	63	85.73	68.25	81.54	63.50	14.28
2.625	65	85.73	71.24	86.22	69.85	15.90
2.750	70	88.90	74.60	89.40	73.03	15.90
2.875	73	95.25	77.77	92.57	73.03	15.90
3.000	75	98.43	80.95	95.75	73.03	15.90

TB1A

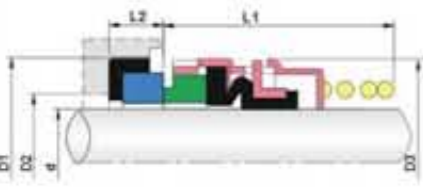

STOCK MATERIALS AND FACE MATERIAL CODE	
Rotary Face	Stationary Face
CAR	CER
CAR	SIC
SIC	SIC

Elastomers: VIT, EPDM, NBR

规格/Size (英寸/Inch)	d	D3	D2	D1	L1	L2	规格/Size (公制/Metric)	d	D3	L1
0.375	9.5	22	11.0	24.60	44	8.7	14	14	29	44
0.500	12.7	25	13.5	27.80	44	8.7	16	16	29	44
0.625	15.8	29	17.0	30.95	44	10.3	18	18	32	44
0.750	19.0	32	20.0	34.15	44	10.3	19	19	32	44
0.813	20.6	33	21.5	35.70	44	10.3	20	20	33	44
0.875	22.2	35	23.0	37.30	44	10.3	24	24	38	44
1.000	25.4	38	26.5	40.50	44	10.3	25	25	38	44
1.125	28.5	46	29.5	47.65	60	11.9	27	27	46	60
1.250	31.7	49	32.5	50.80	60	11.9	28	28	46	60
1.375	34.9	52	36.5	54.00	60	11.9	29	29	46	60
1.500	38.1	56	39.5	57.15	60	11.9	30	30	49	60
1.625	41.2	59	42.5	60.35	60	11.9	32	32	49	60
1.750	44.4	62	46.0	63.50	71	11.9	34	34	52	60
1.875	47.6	65	49.0	66.70	71	11.9	35	35	52	60
2.000	50.8	68	52.0	69.85	71	13.5	38	38	56	60
2.215	53.9	71	55.5	73.50	71	13.5	40	40	59	60
2.250	57.1	75	58.5	76.20	71	13.5	42	42	62	71
2.375	60.3	78	61.5	79.40	71	13.5	45	45	62	71
2.500	63.5	81	65.0	82.55	71	13.5	48	48	65	71
2.625	66.6	86	68.0	92.10	70	15.9	50	50	68	71
2.750	69.8	89	71.0	95.25	70	15.9	54	54	71	71
2.875	73.0	92	74.5	98.45	73	15.9	55	55	75	71
3.000	76.2	95	77.5	101.60	73	15.9	60	60	78	71
3.125	79.3	102	80.5	111.15	79	19.9	65	65	86	70
3.250	82.5	105	84.0	114.30	79	19.9	70	70	89	70
3.375	85.7	108	87.0	117.50	79	19.9	73	73	92	73
3.500	88.9	111	90.5	120.65	79	19.9	75	75	95	73
3.625	92.0	114	93.5	123.85	83	19.9	80	80	105	79
3.375	95.2	117	96.5	127.00	83	19.9	90	90	114	83
3.875	98.4	121	100.0	130.20	86	19.9	95	95	118	83
4.000	101.6	124	103.0	133.35	86	19.9	100	100	124	86

TB1B

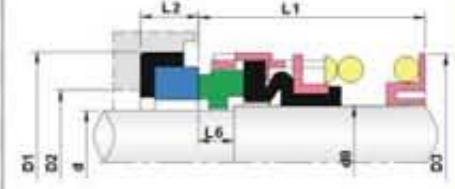

STOCK MATERIALS AND FACE MATERIAL CODE	
Rotary Face	Stationary Face
CAR	CER
CAR	SIC
SIC	SIC

Elastomers: VIT, EPDM, NBR

规格/Size (英寸/Inch)	d	D3	D2	D1	L1	L2	L6
1.000	25.4	38.10	33.32	41.28	47.63	11.10	8.70
1.125	28.5	41.28	36.50	44.44	49.20	11.10	8.70
1.250	31.7	46.02	39.70	47.36	49.20	11.10	8.70
1.375	34.9	47.63	42.84	50.80	50.80	11.10	8.70
1.500	38.1	50.80	46.05	53.98	50.80	11.10	8.70
1.625	41.2	57.15	50.80	60.33	60.33	12.70	11.10
1.750	44.4	60.33	53.97	63.50	60.33	12.70	11.10
1.825	47.6	63.50	57.15	66.68	63.50	12.70	11.10
2.000	50.8	66.68	60.32	69.85	63.50	12.70	11.10
2.120	53.9	71.42	60.32	76.20	69.85	14.27	12.70
2.250	57.1	74.60	61.90	79.38	69.85	14.27	12.70
2.375	60.3	77.77	67.39	82.55	73.03	14.27	12.70
2.500	63.5	80.95	68.25	85.73	73.03	14.27	12.70
2.625	66.6	85.73	71.42	85.73	79.38	15.88	14.27
2.750	69.8	88.90	74.60	88.90	79.38	15.88	14.27
2.875	73.0	92.08	77.77	95.25	82.55	15.88	14.27
3.000	76.2	95.25	80.95	98.43	82.55	15.88	14.27
3.125	79.3	101.60	84.12	101.60	88.90	19.84	15.88
3.250	82.5	104.78	87.30	104.78	88.90	19.84	15.88
3.375	85.7	107.85	90.47	107.95	88.92	19.84	15.88
3.500	88.9	111.13	93.65	111.13	88.90	19.84	15.88
3.625	92.0	114.30	96.82	114.30	92.08	19.84	15.88
3.750	95.2	117.48	100.00	117.48	93.08	19.84	15.88
3.875	98.4	120.65	103.17	120.65	95.25	19.84	15.88
4.000	101.6	123.83	106.35	123.85	95.25	19.84	15.88

TB2

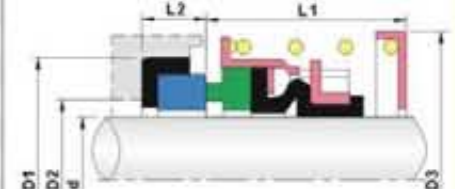

STOCK MATERIALS AND FACE MATERIAL CODE	
Rotary Face	Stationary Face
CAR	CER
CAR	SIC
SIC	SIC

Elastomers: VIT, EPDM, NBR

规格/Size (英寸/Inch)	规格/Size (公制/Metric)	D1	D2	D3	L1	L2
0.500	12	25.40	19.05	30.14	20.64	7.93
	14	31.75	23.80	33.32	22.23	10.28
0.625	16	31.75	23.80	33.32	22.23	10.28
0.750	18	34.93	26.98	36.50	22.23	10.28
	20	38.10	30.15	39.67	23.80	10.28
0.875	22	38.10	30.15	39.67	23.80	10.28
	24	41.28	33.32	45.50	25.40	11.10
1.000	25	41.28	33.32	45.50	25.40	11.10
1.125	28	44.44	36.50	48.50	26.97	11.10
	30	47.63	37.90	52.37	26.97	11.10
1.250	32	47.63	37.90	52.37	26.97	11.10
	33	50.80	42.84	56.00	28.58	11.10
1.375	35	50.80	42.84	56.00	28.58	11.10
1.500	38	53.98	46.05	59.20	28.58	11.10
1.625	40	60.38	50.80	67.00	34.93	12.70
	43	63.50	53.97	69.85	34.93	12.70
1.750	45	63.50	53.97	69.85	34.93	12.70
1.875	48	66.68	57.15	73.03	38.10	12.70
	48	69.85	60.32	73.03	38.10	12.70
2.000	50	69.85	60.32	76.20	38.10	12.70
2.125	53	76.20	60.32	82.55	42.85	14.28
2.250	55	79.38	61.09	85.73	42.85	14.28
2.375	60	82.55	67.39	88.90	46.02	14.28
2.500	63	85.73	68.25	92.08	46.02	14.28
2.625	65	85.73	71.24	98.43	49.20	15.90
2.750	70	88.90	74.60	101.60	49.20	15.90
2.875	73	95.25	77.77	104.78	52.37	15.90
3.000	75	98.43	80.95	107.95	52.37	15.90



TB20 / 20T

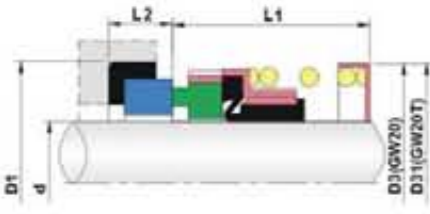

STOCK MATERIALS AND FACE MATERIAL CODE	
Rotary Face	Stationary Face
CAR	CER
CAR	SIC
SIC	SIC
Elastomers: VIT, EPDM, NBR	

规格/Size (公制/Metric)	D3	D31	D1	L2	L1
10	22.95	20.5	24.60	8.74	25.60
11	23.90	22.8	27.79	8.74	25.60
12	23.90	24.0	27.79	8.74	25.60
13	26.70	24.2	30.95	10.32	25.60
14	26.70	26.7	30.95	10.32	25.60
15	26.70	26.7	30.95	10.32	25.60
16	31.10	30.4	34.15	10.32	25.60
18	31.10	30.4	34.15	10.32	25.60
19	33.40	30.4	35.70	10.32	25.60
20	33.40	33.4	37.30	10.32	25.60
22	39.20	33.4	40.50	10.32	25.60
24	39.20	38.0	40.50	10.32	25.60
25	46.30	39.3	47.63	10.32	25.60
28	49.40	42.0	50.80	11.99	33.54
30	49.40	43.9	50.80	11.99	33.54
32	49.40	45.8	53.98	11.99	33.54
33	52.60	45.8	53.98	11.99	33.54
35	52.60	49.3	53.98	11.99	33.54
38	55.80	52.8	57.15	11.99	33.54
40	62.20	55.8	60.35	11.99	33.54
42	66.00	58.8	63.50	11.99	40.68
43	66.00	58.8	63.50	11.99	40.68
44	66.00	58.8	63.50	11.99	40.68
45	66.00	61.0	63.50	11.99	40.68
48	66.00	64.0	66.70	11.99	40.68
50	71.65	66.0	69.85	13.50	40.68
53	73.30	71.5	73.05	13.50	41.20
55	78.40	71.5	76.00	13.50	41.20
58	82.00	79.6	79.40	13.50	41.20
60	82.00	79.6	79.40	13.50	41.20
63	84.90	81.5	82.50	13.50	41.20
65	88.40	84.6	92.10	15.90	49.20
70	92.60	90.0	95.52	15.90	49.20
73	94.85	92.0	98.45	15.90	49.20
75	101.90	96.8	101.65	15.90	49.20

规格/Size (英制/Inch)	D	D3	D31	D1	L2	L1
0.375"	9.5	22.95	20.0	24.60	8.74	25.60
0.500"	12.7	23.90	22.8	27.79	8.74	25.60
0.625"	15.8	26.70	26.7	30.95	10.32	25.60
0.750"	19.1	31.10	30.4	34.15	10.32	25.60
0.875"	22.2	33.40	33.4	37.30	10.32	25.60
1.000"	25.4	43.20	39.3	40.50	10.32	25.60
1.125"	28.6	46.30	42.0	47.63	11.99	33.54
1.250"	31.7	49.40	45.8	50.80	11.99	33.54
1.375"	34.9	52.60	49.3	53.98	11.99	33.54
1.500"	38.1	55.80	52.8	57.15	11.99	33.54
1.625"	41.2	62.20	55.5	60.35	11.99	33.54
1.750"	44.4	66.00	61.0	63.50	11.99	40.68
1.875"	47.6	66.00	64.0	66.70	11.99	40.68
2.000"	50.8	73.00	66.0	69.85	13.50	40.68
2.125"	53.9	73.30	71.5	73.05	13.50	41.20
2.250"	57.1	78.40	79.6	76.20	13.50	41.20
2.375"	60.3	82.00	79.6	79.40	13.50	41.20
2.500"	63.5	84.90	81.5	82.55	13.50	41.20
2.625"	66.6	88.40	84.6	92.10	15.90	49.20
2.750"	69.8	92.60	90.0	95.52	15.90	49.20
2.875"	73.0	94.85	92.0	98.45	15.90	49.20
3.000"	76.2	101.90	96.8	101.65	15.90	49.20

TB21 / 21T

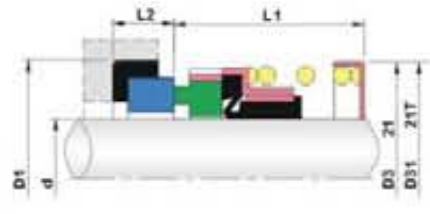

STOCK MATERIALS AND FACE MATERIAL CODE	
Rotary Face	Stationary Face
CAR	CER
CAR	SIC
SIC	SIC
Elastomers: VIT, EPDM, NBR	

规格/Size (英制/Inch)	d	D3	D31	D1	L1	L2
0.500	12.7	24.0	22.80	25.40	20.62	7.95
0.625	15.8	26.7	26.70	31.75	22.23	10.31
0.750	19.1	31.2	30.40	34.93	22.23	10.31
0.875	22.2	33.5	33.40	38.10	23.80	10.31
1.000	25.4	43.2	39.30	41.28	25.40	11.10
1.125	28.6	46.5	42.00	44.45	26.97	11.10
1.250	31.7	49.5	45.80	47.63	26.97	11.10
1.375	34.9	52.7	49.30	50.80	28.58	11.10
1.500	38.1	56.0	52.80	53.98	28.58	11.10
1.625	41.2	62.2	55.50	60.33	34.93	12.70
1.750	44.4	66.0	61.00	63.50	34.93	12.70
1.875	47.6	66.0	64.00	66.68	38.10	12.70
2.000	50.8	73.0	66.00	69.85	38.10	12.70
2.125	53.9	73.5	71.50	76.20	42.85	14.27
2.250	57.1	79.6	79.60	79.38	42.85	14.27
2.375	60.3	82.0	79.60	82.55	46.05	14.27
2.500	63.5	85.0	81.50	85.73	46.05	14.27
2.625	66.6	88.5	84.60	85.73	49.20	15.88
2.750	69.8	92.7	90.00	88.90	49.20	15.88
3.000	76.2	102.0	96.80	98.40	52.37	15.88

规格/Size (公制/Metric)	d	D3	D2	D1	L1	L2
10	10	20.05	17	21	23.9	8.6
12	12	21.70	19	23	23.9	8.6
14	14	24.00	21	25	26.4	8.6
16	16	26.65	23	27	26.4	8.6
18	18	30.35	27	33	27.5	10.0
20	20	33.50	29	35	27.5	10.0
22	22	33.55	31	37	27.5	10.0
24	24	38.00	33	39	30.0	10.0
25	25	39.50	34	40	30.0	10.0
28	28	42.20	37	43	32.5	10.0
30	30	43.95	39	45	32.5	10.0
32	32	46.00	42	48	32.5	10.0
33	33	46.00	42	48	32.5	10.0
35	35	49.10	44	50	32.5	10.0
38	38	53.00	49	56	34.0	11.0
40	40	56.00	51	58	34.0	11.0
43	43	58.80	54	61	34.0	11.0
45	45	61.20	56	63	34.0	11.0
48	48	64.00	59	66	34.0	11.0
50	50	66.00	62	70	34.5	13.0
53	53	70.65	65	73	34.5	13.0
55	55	71.65	67	75	34.5	13.0
58	58	79.60	70	78	39.5	13.0
60	60	78.40	72	80	39.5	13.0
63	63	81.50	75	83	39.5	13.0
65	65	84.30	77	85	39.5	13.0
68	68	89.65	81	90	37.2	15.3
70	70	89.65	83	92	44.7	15.3
75	75	96.80	88	97	44.7	15.3
80	80	104.00	95	105	44.3	15.7
85	85	107.95	100	110	44.3	15.7
90	90	111.10	105	115	49.3	15.7
95	95	119.00	110	120	49.3	15.7
100	100	124.00	115	125	49.3	15.7

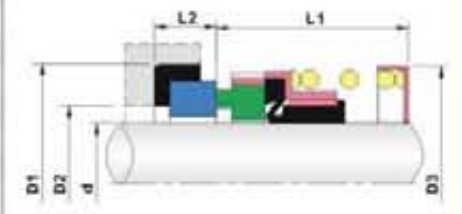

STOCK MATERIALS AND FACE MATERIAL CODE	
Rotary Face	Stationary Face
CAR	CER
CAR	SIC
SIC	SIC
Elastomers: VIT, EPDM, NBR	

TB24

TB560A

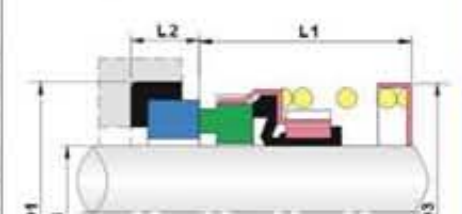

STOCK MATERIALS AND FACE MATERIAL CODE	
Rotary Face	Stationary Face
CAR	CER
CAR	SIC
SIC	SIC
Elastomers: VIT, EPDM, NBR	

规格/Size (公制/Metric)	d	D3	D1	L2	L1	规格/Size (英制/Inch)	d	D3	D1	L2	L1
560A-8	8	18.2	21	7	11.2	560A-3/8	9.52	23.5	22.22	6.4	22.2
560A-9	9	18.2	24	7	16.2	560A-1/2	12.7	26.0	25.40	6.4	22.2
560A-10	10	20.6	24	7	16.2	560A-5/8	15.8	30.0	31.75	8.7	23.8
560A-11	11	20.6	24	7	16.2	560A-3/4	19.1	32.5	34.92	8.7	23.8
560A-12	12	21.8	26	7	17.2	560A-7/8	22.2	37.5	38.10	8.7	25.4
560A-13	13	21.9	26	7	17.2	560A-1	25.4	44.0	41.27	9.5	27.0
560A-14	14	26.4	28	7	18.2	560A-1-1/8	28.6	48.0	44.45	9.5	28.6
560A-15	15	26.4	28	7	18.2	560A-1-1/4	31.7	50.0	47.62	9.5	28.6
560A-16	16	26.4	32	8	19.2	560A-1-3/8	34.9	54.5	50.80	9.5	30.2
560A-17	17	29.5	32	8	19.2	560A-1-1/2	38.1	58.5	53.97	9.5	30.2
560A-18	18	29.5	35	8	19.2	560A-1-5/8	41.2	64.0	60.32	11.1	36.5
560A-19	19	29.5	35	8	19.2	560A-1-3/4	44.4	67.0	63.50	11.1	36.5
560A-20	20	31.6	38	8	20.2	560A-1-7/8	47.6	71.0	66.67	11.1	39.7
560A-22	22	33.6	40	8	20.2	560A-2	50.8	73.5	69.85	11.1	39.7
560A-25	25	39.6	44	9	20.2						
560A-28	28	45.0	46	9	21.2						
560A-30	30	46.6	50	9	22.2						
560A-32	32	46.6	54	9	24.2						
560A-35	35	50.8	58	10	26.2						
560A-38	38	54.3	60	10	27.2						
560A-40	40	57.3	64	10	28.2						
560A-45	45	61.3	66	10	30.2						
560A-50	50	67.8	72	10	32.2						



TBFBDD

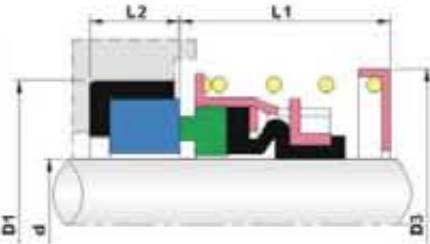

STOCK MATERIALS AND FACE MATERIAL CODE	
Rotary Face	Stationary Face
CAR	CER
CAR	SIC
SIC	SIC
Elastomers: VIT , EPDM , NBR	

规格/Size (公制/Metric)	d	D3	D1	L1	L2
16	16	34.0	30	25	8
18	18	36.8	32	25	8
20	20	38.8	34	25	8
22	22	41.5	36	25	8
25	25	44.8	39	26	8
28	28	48.5	43	26	8
30	30	52.0	48	26	8
35	35	57.0	53	30	10
40	40	67.0	58	34	10
45	45	73.0	63	36	10
50	50	79.0	68	41	10
55	55	84.0	73	41	12
60	60	90.0	79	41	12
65	65	98.5	86	49	12
70	70	103.5	91	52	12
75	75	110.5	96	52	12
80	80	120.0	105	56	14
85	85	125.0	110	56	14
90	90	132.0	115	56	14
95	95	137.0	120	56	14
100	100	144.0	125	62	14
110	110	157.0	135	62	16
120	120	169.5	145	72	16

TBBI A

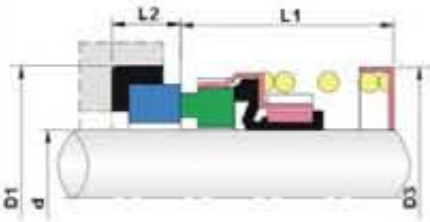

STOCK MATERIALS AND FACE MATERIAL CODE	
Rotary Face	Stationary Face
CAR	CER
CAR	SIC
SIC	SIC
Elastomers: VIT , EPDM , NBR	

规格/Size (公制/Metric)	d	D3	D1	L1	L2
14	14	27.5	30	19.0	5.0
16	16	28.5	32	21.0	5.0
18	18	31.2	35	22.5	7.5
20	20	31.7	35	21.0	8.0
25	25	40.2	40	25.5	8.0
28	28	44.1	43	25.5	8.0
30	30	45.1	45	25.5	9.0
32	32	49.0	48	33.5	9.0
33	33	49.0	48	33.5	9.0
35	35	50.2	50	33.5	9.0
38	38	55.3	56	33.5	9.0
40	40	57.0	58	33.5	9.0
43	43	60.7	61	36.5	9.5
45	45	62.5	63	38.0	9.5
48	48	66.5	66	38.0	9.5
50	50	68.6	70	38.0	9.5
53	53	70.8	73	41.0	9.5
55	55	72.4	75	41.0	9.5
58	58	80.0	78	42.0	9.5
60	60	83.0	80	42.0	9.5
65	65	87.2	85	42.0	10.0
70	70	91.6	92	45.0	11.0
75	75	99.4	97	47.0	12.0
80	80	104.6	104	55.0	12.0
85	85	111.0	109	64.0	12.0
90	90	113.0	114	66.0	12.0

TBMG912

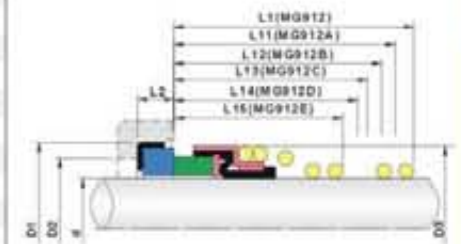

STOCK MATERIALS AND FACE MATERIAL CODE	
Rotary Face	Stationary Face
CAR	CER
CAR	SIC
SIC	SIC
Elastomers: VIT , EPDM , NBR	

规格/Size (公制/Inch)	d	D3	D2	D1	L1	L11	L14	L15	L2
0.375	9.5	18.8	15.88	22.23	44.0	30.15	25.0	20.63	7.95
0.500	12.7	22.3	19.05	25.40	44.0	30.15	25.0	20.63	7.95
0.625	15.8	26.5	23.80	31.75	44.0	33.33	25.0	22.23	10.31
0.750	19.0	29.5	26.97	34.93	44.0	33.33	25.0	22.23	10.31
0.875	22.2	33.0	30.15	38.10	44.0	34.93	25.0	23.80	10.31
1.000	25.4	38.0	33.32	41.28	44.0	39.70	25.0	25.40	11.10
1.125	28.5	41.5	36.50	44.45	60.0	41.27	33.0	27.00	11.10
1.250	31.7	45.0	39.70	47.63	60.0	41.27	33.0	27.00	11.10
1.375	34.9	48.0	42.85	50.80	60.0	42.85	33.0	28.57	11.10
1.500	38.1	52.5	46.05	53.98	60.0	42.85	33.0	28.57	11.10
1.625	41.2	57.0	50.80	60.33	60.0	50.80	33.0	34.93	12.70
1.750	44.4	60.5	53.97	63.50	71.0	50.80	41.0	34.93	12.70
1.875	47.6	64.0	57.15	66.68	71.0	53.98	41.0	38.10	12.70
2.000	50.8	66.0	60.33	69.85	72.5	53.98	42.5	38.10	12.70
2.125	53.9	71.0	60.33	76.20	71.0	60.33	41.0	42.85	14.27
2.250	57.1	76.5	61.90	79.38	71.0	60.33	41.0	42.85	14.27
2.375	60.3	78.5	65.10	82.55	71.0	63.50	41.0	46.06	14.27
2.500	63.5	82.0	68.25	85.73	71.0	63.50	41.0	46.06	14.27
2.625	66.6	84.0	72.42	85.73	70.0	69.85	49.0	49.19	15.88
2.750	69.8	89.0	74.60	88.90	70.0	69.85	49.0	49.19	15.88
2.875	73.0	92.5	77.77	95.25	73.0	73.02	52.0	52.37	15.88
3.000	76.2	95.5	80.95	98.43	73.0	73.02	52.0	52.37	15.88
3.125	79.3	101.6	84.12	101.60	79.0	79.37	56.0	55.55	19.84
3.250	82.5	-	87.30	104.78	79.0	79.37	56.0	55.55	19.84
3.375	85.7	-	90.47	107.95	79.0	79.37	56.0	55.55	19.84
3.500	88.9	111.5	93.65	111.13	79.0	79.37	56.0	55.55	19.84
3.625	92.0	-	96.82	114.30	83.0	82.55	59.0	58.72	19.84
3.750	95.2	118.0	100.00	117.48	83.0	82.55	59.0	58.72	19.84
3.875	98.4	-	103.17	120.65	86.0	85.72	62.0	61.90	19.84
4.000	101.6	125.0	106.35	123.83	86.0	85.72	62.0	61.90	19.84

规格/Size (公制/Metric)	d	D3	D2	D1	L1	L12	L13	L14	L2
10	10	19.6	17	21	44.0	33.4	25.9	25.0	6.6
12	12	21.6	19	23	44.0	33.4	25.9	25.0	6.6
14	14	24.0	21	25	44.0	33.4	28.4	25.0	6.6
15	15	25.0	-	-	44.0	-	-	25.0	-
16	16	26.5	23	27	44.0	33.4	28.4	25.0	6.6
18	18	29.0	27	33	44.0	37.5	30.0	25.0	7.5
20	20	31.5	29	35	44.0	37.5	30.0	25.0	7.5
22	22	33.0	31	37	44.0	37.5	30.0	25.0	7.5
24	24	37.0	33	39	44.0	42.5	32.5	25.0	7.5
25	25	38.0	34	40	44.0	42.5	32.5	25.0	7.5
28	28	41.0	37	43	60.0	42.5	35.0	33.0	7.5
30	30	43.0	39	45	60.0	42.5	35.0	33.0	7.5
32	32	45.0	42	48	60.0	47.5	35.0	33.0	7.5
33	33	46.0	42	48	60.0	47.5	35.0	33.0	7.5
35	35	48.0	44	50	60.0	47.5	35.0	33.0	7.5
38	38	52.5	49	56	60.0	46.0	36.0	33.0	9.0
40	40	55.5	51	58	60.0	46.0	36.0	33.0	9.0
43	43	58.5	54	61	71.0	51.0	36.0	41.0	9.0
45	45	60.5	56	63	71.0	51.0	36.0	41.0	9.0
48	48	64.0	59	66	71.0	51.0	36.0	41.0	9.0
50	50	66.0	62	70	72.5	50.5	38.0	42.5	9.5
53	53	69.0	65	73	71.0	59.0	36.5	41.0	11.0
55	55	71.0	67	75	71.0	59.0	36.5	41.0	11.0
58	58	76.0	70	78	71.0	59.0	41.5	41.0	11.0
60	60	78.0	72	80	71.0	59.0	41.5	41.0	11.0
63	63	82.0	75	83	-	59.0	41.5	-	11.0
65	65	84.0	77	85	70.0	69.0	41.5	49.0	11.0
68	68	87.0	81	90	70.0	68.7	41.2	49.0	11.3
70	70	89.0	83	92	70.0	68.7	48.7	49.0	11.3
75	75	95.0	88	97	73.0	68.7	48.7	52.0	11.3
80	80	101.5	95	105	79.0	78.0	48.0	56.0	12.0
85	85	-	100	110	79.0	76.0	46.0	56.0	14.0
90	90	111.5	105	115	83.0	76.0	51.0	59.0	14.0
95	95	-	110	120	83.0	76.0	51.0	59.0	14.0
100	100	122.5	115	125	86.0	76.0	51.0	62.0	14.0



TB6



规格/Size (英寸/Inch)	d	D3	D1	L1	L2
0.375	9.5	23.29	22.23	16.66	7.14
0.500	12.7	23.29	25.40	16.66	6.35
0.625	15.8	30.10	31.75	18.24	10.31
0.750	19.0	33.07	34.93	18.24	10.31
0.875	22.2	36.30	38.10	20.63	10.31
1.000	25.4	39.42	41.28	20.63	11.10

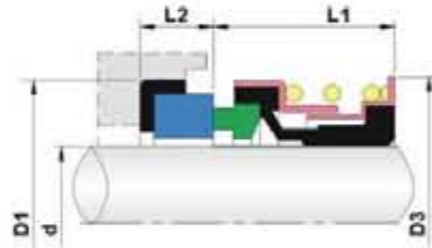

STOCK MATERIALS AND FACE MATERIAL CODE	
Rotary Face	Stationary Face
CAR	CER
CAR	SIC
SIC	SIC

Elastomers: VIT, EPDM, NBR

TB60 / 65



规格/Size (英寸/Inch)	d	D3	D1	L1	L2
TB60/0.375	9.5	24.00	22.2	16.00	6.20
TB60/0.500	12.7	27.00	25.4	16.60	6.20
TB60/0.625	15.8	31.00	31.8	18.70	10.31
TB60/0.750	19.0	34.20	34.9	18.70	10.31
TB60/1.000	25.4	43.00	41.3	20.60	11.10
TB65/0.375	9.5	27.00	25.4	16.60	7.90
TB65/0.500	12.7	27.00	25.4	16.60	7.90
TB65/0.625	15.8	31.00	31.7	18.20	10.30
TB65/0.750	19.1	34.20	34.9	18.20	10.30
TB65/1.750	63.5	51.59	61.0	33.34	10.32

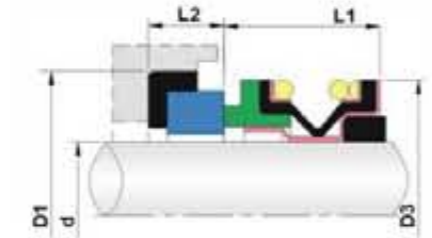

STOCK MATERIALS AND FACE MATERIAL CODE	
Rotary Face	Stationary Face
CAR	CER
CAR	SIC
SIC	SIC

Elastomers: VIT, EPDM, NBR

TB140 / 142 / 143

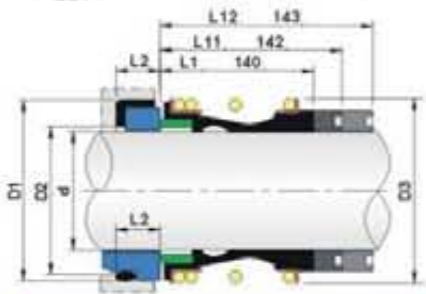

STOCK MATERIALS AND FACE MATERIAL CODE	
Rotary Face	Stationary Face
CAR	CER
CAR	SIC
SIC	SIC

Elastomers: VIT, EPDM, NBR

规格/Size (公制/Metric)	D1	D2	D3	L1	L11	L12	L2
10	21.0	17.0	20.0	13.4	25.9	33.4	6.6
12	23.0	19.0	22.0	14.4	25.9	33.4	6.6
14	25.0	21.0	24.0	14.4	28.4	33.4	6.6
15	27.0	23.0	25.0	14.4	28.4	33.4	6.6
16	27.0	23.0	26.0	14.4	28.4	33.4	6.6
18	33.0	27.0	32.0	18.5	30.0	37.5	7.5
20	35.0	29.0	34.0	18.5	30.0	37.5	7.5
22	37.0	31.0	36.0	18.5	30.0	37.5	7.5
24	39.0	33.0	38.0	18.5	32.5	42.5	7.5
25	40.0	34.0	39.0	18.5	32.5	42.5	7.5
28	43.0	37.0	42.0	24.5	35.0	42.5	7.5
30	45.0	39.0	44.0	25.5	35.0	42.5	7.5
32	48.0	42.0	46.0	25.5	35.0	47.5	7.5
33	48.0	42.0	47.0	25.5	35.0	47.5	7.5
35	50.0	44.0	49.0	26.5	35.0	47.5	7.5
38	56.0	49.0	54.0	29.0	36.0	46.0	9.0
40	58.0	51.0	56.0	29.0	36.0	46.0	9.0
43	61.0	54.0	59.0	29.0	36.0	51.0	9.0
45	63.0	56.0	61.0	29.0	36.0	51.0	9.0
48	66.0	59.0	64.0	31.0	36.0	51.0	9.0
50	70.0	62.0	66.0	30.5	38.0	50.5	9.5
53	73.0	65.0	69.0	29.0	36.5	59.0	11.0
55	75.0	67.0	71.0	29.0	36.5	59.5	11.0
58	78.0	70.0	78.0	32.0	41.5	59.5	11.0
60	80.0	72.0	80.0	34.0	41.5	59.5	11.0
65	85.0	77.0	85.0	34.0	41.5	69.0	11.0
68	90.0	81.0	88.0	33.7	41.2	68.7	11.3
70	92.0	83.0	90.0	33.7	48.7	68.7	11.3
75	97.0	88.0	99.0	40.7	48.7	68.7	11.3
80	105.0	95.0	104.0	40.5	48.0	78.0	12.0
85	110.0	100.0	109.0	38.5	46.0	76.0	14.0
90	115.0	105.0	114.0	38.5	51.0	76.0	14.0
95	120.0	110.0	119.0	38.5	51.0	76.0	14.0
100	125.0	115.0	124.0	38.5	51.0	76.0	14.0

TB150



规格/Size (公制/Metric)	D1	D2	D3	L1	L2	L3
10	24.60	16.00	20.0	25.40	8.74	7.47
12	27.79	19.05	22.0	25.40	8.74	7.47
13	27.79	19.05	22.0	25.40	8.74	7.47
14	30.95	22.23	24.0	25.40	10.32	8.97
15	30.95	22.23	25.0	25.40	10.32	8.97
16	30.95	22.23	26.0	25.40	10.32	8.97
18	34.15	25.40	32.0	25.40	10.32	8.97
19	34.15	25.40	32.0	25.40	10.32	8.97
20	35.70	26.99	34.0	25.40	10.32	8.97
22	37.30	28.58	36.0	25.40	10.32	8.97
24	40.50	31.75	38.0	25.40	10.32	8.97
25	40.50	31.75	39.0	25.40	10.32	8.97
28	47.63	35.72	42.0	33.34	11.99	10.46
30	50.80	38.89	44.0	33.34	11.99	10.46
32	50.80	38.89	46.0	33.34	11.99	10.46
33	53.98	42.07	47.0	33.34	11.99	10.46
34	53.98	42.07	49.0	33.34	11.99	10.46
35	53.98	42.07	49.0	33.34	11.99	10.46
38	57.15	45.24	54.0	33.34	11.99	10.46
40	60.35	48.42	56.0	33.34	11.99	10.46
42	63.50	51.59	59.0	40.48	11.99	10.46
43	63.50	51.59	59.0	40.48	11.99	10.46
44	63.50	51.59	61.0	40.48	11.99	10.46
45	63.50	51.59	61.0	40.48	11.99	10.46
48	66.70	54.75	64.0	40.48	11.99	10.46
50	69.85	58.00	66.0	40.48	13.50	10.46
53	73.05	62.00	69.0	41.00	13.50	11.96
55	76.20	65.00	71.0	41.00	13.50	11.96
58	79.40	68.00	78.0	41.00	13.50	11.96
60	79.40	68.00	80.0	41.00	13.50	11.96
63	82.55	71.20	83.0	41.00	13.50	11.96
65	92.10	78.35	85.0	49.00	15.90	14.50
70	95.25	81.10	90.0	49.00	15.90	14.50
73	98.45	84.50	96.0	49.00	15.90	14.50
75	101.65	88.10	99.0	49.00	15.90	14.50
80	114.30	97.00	104.0	56.00	20.00	18.50
85	117.50	100.00	109.0	56.00	20.00	18.50
90	123.85	107.00	114.0	59.00	20.00	18.50
95	127.00	110.00	119.0	59.00	20.00	18.50
100	133.35	116.00	124.0	62.00	20.00	18.50

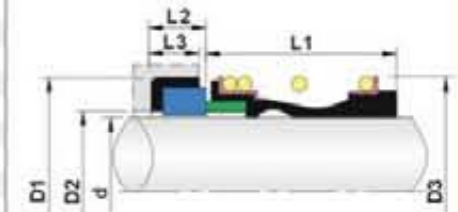

STOCK MATERIALS AND FACE MATERIAL CODE	
Rotary Face	Stationary Face
CAR	CER
CAR	SIC
SIC	SIC

Elastomers: VIT, EPDM, NBR

TB150A



规格/Size (英寸/Inch)	D1	D2	D3	L1	L2	L3
0.375	24.60	16.00	20.0	25.40	8.74	7.47
0.500	27.79	19.05	22.0	25.40	8.74	7.47
0.625	30.95	22.23	26.0	25.40	10.32	8.97
0.750	34.15	25.40	32.0	25.40	10.32	8.97
0.875	37.30	28.58	36.0	25.40	10.32	8.97
1.000	40.50	31.75	39.0	25.40	10.32	8.97
1.125	47.63	35.72	42.0	33.34	11.99	10.46
1.250	50.80	38.89	46.0	33.34	11.99	10.46
1.375	53.98	42.07	49.0	33.34	11.99	10.46
1.500	57.15	45.24	54.0	33.34	11.99	10.46
1.625	60.35	48.42	56.0	33.34	11.99	10.46
1.750	63.50	51.59	61.0	40.48	11.99	10.46
1.875	66.70	54.75	64.0	40.48	11.99	10.46
2.000	69.85	58.00	66.0	40.48	13.50	11.96
2.125	73.05	62.00	69.0	41.00	13.50	11.96
2.250	76.20	65.00	78.0	41.00	13.50	11.96
2.375	79.40	68.00	80.0	41.00	13.50	11.96
2.500	82.55	71.20	83.0	41.00	13.50	11.96
2.625	92.10	78.35	85.0	49.00	15.90	14.50
2.750	95.25	81.10	90.0	49.00	15.90	14.50
2.875	98.45	84.50	96.0	49.00	15.90	14.50
3.000	101.65	88.10	99.0	49.00	15.90	14.50
3.125	111.15	93.68	104.0	56.00	20.00	18.50
3.250	114.30	96.85	104.0	56.00	20.00	18.50
3.375	117.50	100.00	109.0	56.00	20.00	18.50
3.500	120.65	103.18	114.0	56.00	20.00	18.50
3.625	123.85	106.35	114.0	59.00	20.00	18.50
3.750	127.00	109.52	119.0	59.00	20.00	18.50
3.875	130.20	112.65	122.0	62.00	20.00	18.50
4.000	133.35	115.88	124.0	62.00	20.00	18.50

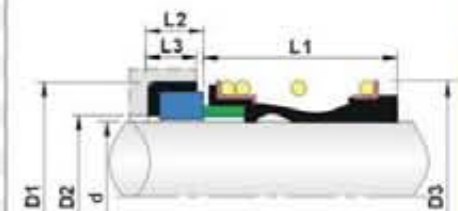

STOCK MATERIALS AND FACE MATERIAL CODE	
Rotary Face	Stationary Face
CAR	CER
CAR	SIC
SIC	SIC

Elastomers: VIT, EPDM, NBR



TB151 / 152

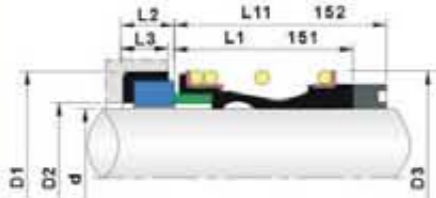

STOCK MATERIALS AND FACE MATERIAL CODE	
Rotary Face	Stationary Face
CAR	CER
CAR	SIC
SIC	SIC

Elastomers: VIT, EPDM, NBR

规格/Size (英寸/Inch)	规格/Size (公制/Metric)	D1	D2	D3	L1	L11	L2	L3
0.500	12	25.40	19.05	22.00	20.62	31.75	7.93	6.35
	14	31.75	23.80	24.00	22.22	34.93	10.28	8.71
0.625	16	31.75	23.80	26.00	22.22	34.93	10.28	8.71
0.750	18	34.93	26.98	32.00	22.22	34.93	10.28	8.71
	20	38.10	30.15	34.00	23.80	36.50	10.28	8.71
0.875	22	38.10	30.15	36.00	23.80	36.50	10.28	8.71
	24	41.28	33.32	38.00	25.40	41.28	11.10	9.53
1.000	25	41.28	33.32	39.00	25.40	41.28	11.10	9.53
1.125	28	44.44	36.50	42.00	26.97	42.85	11.10	9.53
	30	47.63	37.90	44.00	26.97	42.85	11.10	9.53
1.250	32	47.63	37.90	46.00	26.97	42.85	11.10	9.53
	33	50.80	42.84	47.00	28.58	42.85	11.10	9.53
1.375	35	50.80	42.84	49.00	28.58	42.85	11.10	9.53
1.500	38	53.98	46.05	54.00	28.58	42.85	11.10	9.53
1.625	40	60.33	50.80	56.00	34.93	50.80	12.70	11.1
	43	63.50	53.97	59.00	34.93	50.80	12.70	11.1
1.750	44	63.50	53.97	61.00	34.93	50.80	12.70	11.1
1.875	45	66.68	57.15	61.00	38.10	53.98	12.70	11.1
	48	69.85	60.32	64.00	38.10	53.98	12.70	11.1
2.000	50	69.85	60.32	66.00	38.10	53.98	12.70	11.1
2.125	53	76.20	60.32	69.00	42.88	60.32	14.28	12.7
2.250	55	79.38	61.90	78.00	42.88	60.32	14.28	12.7
	58	82.55	67.39	78.00	46.02	63.50	14.28	12.7
2.375	60	82.55	67.39	80.00	46.02	63.50	14.28	12.7
2.500	63	85.73	68.25	83.00	46.02	63.50	14.28	12.7
2.625	65	85.73	71.24	85.00	49.20	69.85	15.90	14.5
	68	88.90	74.60	88.00	49.20	69.85	15.90	14.5
2.750	70	88.90	74.60	90.00	49.20	69.85	15.90	14.5
2.875	73	95.25	77.77	96.00	52.37	73.03	15.90	14.5
3.000	75	98.43	80.95	99.00	52.37	73.03	15.90	14.5

TB210

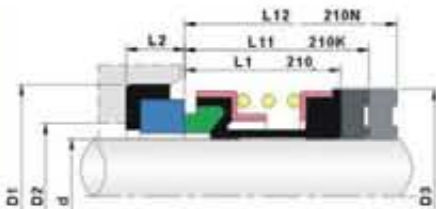

STOCK MATERIALS AND FACE MATERIAL CODE	
Rotary Face	Stationary Face
CAR	CER
CAR	SIC
SIC	SIC

Elastomers: VIT, EPDM, NBR

规格/Size (英寸/Inch)	d	D3	D2	D1	L1	L11	L12	L2	规格/Size (英寸/Inch)	d	D3	L1
10	10	20	15	21	15	27.5	35.0	5.0	0.375	9.5	20.0	15.0
12	12	22	17	23	15	26.5	34.0	6.0	0.500	12.7	24.0	15.0
14	14	24	19	25	15	29.0	34.0	6.0	0.625	15.8	26.0	15.0
15	15	25	20	26	15	29.0	34.0	6.0	0.750	19.0	32.0	20.0
16	16	26	23	27	15	29.0	34.0	6.0	0.875	22.2	36.0	20.0
18	18	32	25	33	20	31.5	39.0	6.0	1.000	25.4	38.0	20.0
20	20	34	27	35	20	31.5	39.0	6.0	1.125	28.5	42.3	26.0
22	22	36	29	37	20	31.5	39.0	6.0	1.250	31.7	46.0	26.0
24	24	38	31	39	20	34.0	44.0	6.0	1.375	34.9	49.0	26.0
25	25	39	32	40	20	34.0	44.0	6.0	1.500	38.1	54.0	30.0
28	28	42	35	43	26	36.5	44.0	6.0	1.625	41.2	56.0	30.0
30	30	44	37	45	26	35.5	43.0	7.0	1.750	44.4	61.0	30.0
32	32	46	40	48	26	35.5	48.0	7.0	1.875	47.6	64.0	30.0
33	33	47	40	48	26	35.5	48.0	7.0	2.000	50.8	66.0	30.0
35	35	49	42	50	26	34.5	47.0	8.0	2.125	53.9	69.0	30.0
38	38	54	47	56	30	37.0	47.0	8.0	2.250	57.1	77.0	33.0
40	40	56	49	58	30	37.0	47.0	8.0	2.375	60.3	80.0	33.0
43	43	59	52	61	30	37.0	52.0	8.0	2.500	63.5	83.0	33.0
45	45	61	54	63	30	37.0	52.0	8.0	2.625	66.6	88.0	33.0
48	48	64	57	66	30	35.0	50.0	10.0	2.750	69.8	89.0	33.0
50	50	66	60	70	30	37.5	50.0	10.0	2.875	73.0	96.0	33.0
53	53	69	63	73	30	37.5	60.0	10.0	3.000	76.2	99.0	40.0
55	55	71	65	75	30	37.5	60.0	10.0	3.125	79.3	103.0	40.0
58	58	78	68	78	33	42.5	60.0	10.0	3.250	82.5	104.0	40.0
60	60	80	70	80	33	40.5	58.0	12.0	3.375	85.7	108.0	40.0
63	63	83	73	83	33	40.5	58.0	12.0	3.500	88.9	112.0	40.0
65	65	85	75	85	33	40.5	68.0	12.0	3.625	92.0	114.0	40.0
68	68	88	79	90	33	40.5	68.0	12.0	3.750	95.2	118.0	40.0
70	70	90	81	92	33	48.0	68.0	12.0	3.875	98.4	122.0	40.0
75	75	99	86	97	40	48.0	68.0	12.0	4.000	101.6	124.0	40.0
80	80	104	92	105	40	47.5	77.5	12.5				
85	85	109	97	110	40	47.5	77.5	12.5				
90	90	114	102	115	40	52.5	77.5	12.5				
95	95	119	117	120	40	52.5	77.5	12.5				
100	100	124	122	125	40	52.5	77.5	12.5				

TBMG1 / MG12 / MG13 / MG20

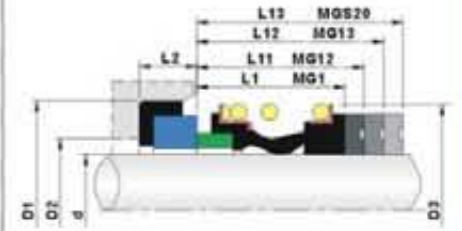

STOCK MATERIALS AND FACE MATERIAL CODE	
Rotary Face	Stationary Face
CAR	CER
CAR	SIC
SIC	SIC

Elastomers: VIT, EPDM, NBR

规格/Size (英寸/Inch)	d	D3	D2	D1	L1	L11	L12	L13	L2
10	10	22.5	17	21	14.5	25.9	33.4	25.0	6.6
12	12	25.0	19	23	15.0	25.9	33.4	25.0	6.6
14	14	28.5	21	25	17.0	28.4	33.4	25.0	6.6
15	15	28.5	-	-	17.0	28.4	33.4	25.0	-
16	16	28.5	23	27	17.0	28.4	33.4	25.0	6.6
18	18	32.0	27	33	19.5	30.0	37.5	25.0	7.5
19	19	37.0	-	-	21.5	30.0	37.5	25.0	-
20	20	37.0	29	35	21.5	30.0	37.5	25.0	7.5
22	22	37.0	31	37	21.5	30.0	37.5	25.0	7.5
24	24	42.5	33	39	22.5	32.5	42.5	25.0	7.5
25	25	42.5	34	40	23.0	32.5	42.5	25.0	7.5
28	28	49.0	37	43	26.5	35.0	42.5	33.0	7.5
30	30	49.0	39	45	26.5	35.0	42.5	33.0	7.5
32	32	53.5	42	48	27.5	35.0	47.5	33.0	7.5
33	33	53.5	42	48	27.5	35.0	47.5	33.0	7.5
35	35	57.0	44	50	28.5	35.0	47.5	33.0	7.5
38	38	59.0	49	56	30.0	36.0	46.0	33.0	9.0
40	40	62.0	51	58	30.0	36.0	46.0	33.0	9.0
42	42	65.5	-	-	30.0	36.0	51.0	41.0	-
43	43	65.5	54	61	30.0	36.0	51.0	41.0	9.0
45	45	68.0	56	63	30.0	36.0	51.0	41.0	9.0
48	48	70.5	59	66	30.5	36.0	51.0	41.0	9.0
50	50	74.0	62	70	30.5	38.0	50.5	41.0	9.5
53	53	78.5	65	73	33.0	36.5	59.0	41.0	11.0
55	55	81.0	67	75	35.0	36.5	59.0	41.0	11.0
58	58	85.5	70	78	37.0	41.5	59.0	41.0	11.0
60	60	88.5	72	80	38.0	41.5	59.0	41.0	11.0
65	65	93.5	77	85	40.0	41.5	69.0	49.0	11.0
68	68	96.5	81	90	40.0	41.2	68.7	49.0	11.3
70	70	99.5	83	92	40.0	48.7	68.7	49.0	11.3
75	75	107.0	88	97	40.0	48.7	68.7	52.0	11.3
80	80	112.0	95	105	40.0	48.0	78.0	56.0	12.0
85	85	120.0	100	110	41.0	46.0	76.0	56.0	14.0
90	90	127.0	105	115	45.0	51.0	76.0	59.0	14.0
95	95	132.0	110	120	46.0	51.0	76.0	59.0	14.0
100	100	137.0	115	125	47.0	51.0	76.0	62.0	14.0

规格/Size (英寸/Inch)	d	D3	D1	L	L2	规格/Size (英寸/Inch)	d	D3	D1	L	L2
6	6	18.0	18.0	14.0	4.0	19	19	39.0	42.0	21.0	8.0
8S	8	18.0	22.0	15.0	4.0	20	20	39.0	42.0	21.0	8.0
8M	8	20.0	22/26	15.0	4/5.5	20L	20	42.0	45.0	23.0	10.0
8L	8	24.0	26.0	15.0	5.5	22S	22	36.0	45.0	26.5	10.0
10	10	24.0	26.0	21.0	8.0	22L	22	42.0	45.0	23.0	10.0
11	11	24.0	26.0	21.0	8.0	23	23	47.0	50.0	23.5	10.0
12	12	24.0	25/26	21.0	8.0	24	24	47.0	50.0	23.5	10.0
13	13	24.0	26.0	19.5	5.5/8	25	25	42.0	50.0	23.5	10.0
13L	13	28.0	28.0	21.0	8.0	25L	2				



TB502

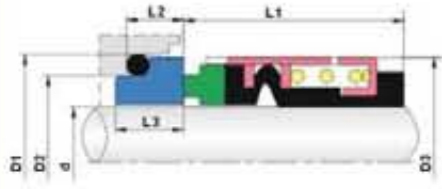

STOCK MATERIALS AND FACE MATERIAL CODE	
Rotary Face	Stationary Face
CAR	CER
CAR	SIC
SIC	SIC
Elastomers: VIT, EPDM, NBR	

规格/Size (公制/Metric)	d	D3	D2	D1	L1	L2	L3
14	14	24	21	25	23.0	12.0	12.8
16	16	26	23	27	23.0	12.0	12.8
18	18	32	27	33	24.0	13.5	14.5
20	20	34	29	35	24.0	13.5	14.5
22	22	36	31	37	24.0	13.5	14.5
24	24	38	33	39	26.7	13.3	14.3
25	25	39	34	40	27.0	13.0	14.0
28	28	42	37	43	30.0	12.5	13.5
30	30	44	39	45	30.5	12.0	13.0
32	32	46	42	48	30.5	12.0	13.0
33	33	47	42	48	30.5	12.0	13.0
35	35	49	44	50	30.5	12.0	13.0
38	38	54	49	56	32.0	13.0	14.0
40	40	56	51	58	32.0	13.0	14.0
43	43	59	54	61	32.0	13.0	14.0
45	45	61	56	63	32.0	13.0	14.0
48	48	64	59	66	32.0	13.0	14.0
50	50	66	62	70	34.0	13.5	14.5
53	53	69	65	73	34.0	13.5	14.5
55	55	71	67	75	34.0	13.5	14.5
58	58	78	70	78	39.0	13.5	14.2
60	60	80	72	80	39.0	13.5	14.2
63	63	83	75	83	39.0	13.5	14.2
65	65	85	77	85	39.0	13.5	14.2
68	68	88	81	90	39.0	13.5	14.2
70	70	89	83	92	45.5	14.5	15.2
75	75	96	88	97	45.5	14.5	15.2
80	80	104	95	105	45.0	15.0	15.7
85	85	108	100	110	45.0	15.0	15.7
90	90	114	105	115	50.0	15.0	15.7
95	95	118	110	120	50.0	15.0	15.7
100	100	124	115	125	50.0	15.0	15.7

TB70

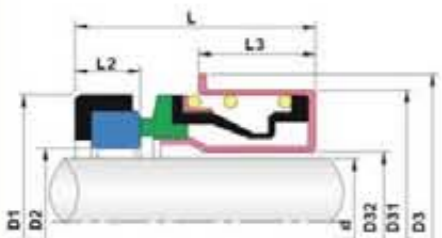

规格/Size (公制/Metric)	Model	D32	D31	D3	D2	D1	L	L2	L3
10.00	10	11.00	24.00	29.0	12.00	23.00	17.00	4.00	7.0
12.00	12S	14.20	28.55	32.0	14.00	25.00	18.20	5.00	8.0
12.00	12M	14.20	30.00	35.0	15.00	24/23	18.00	5.00	8.0
12.00	12L	14.20	33.40	38.0	14.00	25.00	18.00	5.00	6.7
16.00	16	18.20	36.45	41.5	18.00	31.00	19.80	5.00	8.0
16.00	16L	18.20	38.10	43.5	18.00	31.00	19.80	5.00	8.0
16.00	16LD	18.20	38.10	43.5	18.00	31.00	19.80	5.00	8.0
20.00	20S	21.20	38.00	43.8	21.00	35.00	20.50	5.00	9.5
20.00	20	21.20	40.00	43.8	21.00	35.00	20.50	5.00	9.5
25.00	25S	26.40	46.00	51.0	26.00	44.00	25.00	7.00	10.0
25.00	25M	26.40	47.00	51.0	26.00	44.00	25.00	7.00	12.0
25.00	25L	26.40	52.00	57.0	27.00	48.00	25.00	7.00	12.0
30.00	30	31.00	52.00	57.0	32.00	48.00	27.00	8.00	11.0
12.70	1/2"	14.20	30.00	35.0	13.50	25.40	19.20	6.20	8.0
25.80	5/8"	18.20	36.45	41.5	17.50	31.75	25.00	10.30	8.0
19.05	3/4"	21.20	40.00	43.8	20.00	34.93	25.80	10.30	9.5
25.40	1"	26.40	47.00	51.0	27.00	41.28	29.00	11.10	12.0

规格/Size (公制/Metric)	D3	D2	D1	L2	L1	L11	规格/Size (英寸/Inch)	D3	D2	D1	L2	L1	L11
25	60	60	47	27	42	45	25.4	60	54	42.86	17.5	42	45
30	67	67	53	27	42	45	28.6	67	60	46.03	27	42	45
32	69	64	50.7	27	42	45	31.75	69	65	50.80	27	42	45
35	72	70	57	27	42	45	34.93	72	68	53.98	27	42	45
40	78	76	62	26	42	45	38.1	76	71	57.15	27	42	45
45	84	82	67	27	44	46	41.28	80	78	63.50	27	42	45
50	88	86	72	27	46	46	44.45	84	81	66.68	27	44	46
55	95	90	77	27	46	46	47.63	86	84	69.85	27	44	46
60	100	95	82	27	46	46	50.8	90	87	73.03	27	46	46
65	105	100	87	27	46	46	53.98	95	97	79.38	33.5	46	46
							57.15	98	100	82.55	33.5	46	46
							60.3	100	103	85.73	33.5	46	46

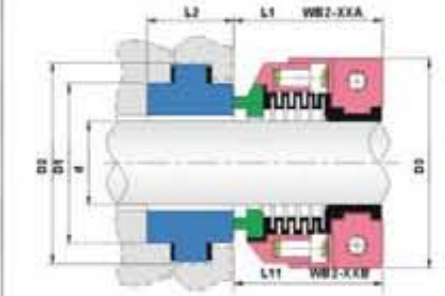

STOCK MATERIALS AND FACE MATERIAL CODE	
Rotary Face	Stationary Face
PTFE	CER
Elastomers: PTFE	

TBWB2

规格/Size (英寸/Inch)	d	D3	D2	D1	L1	L2
0.500	12.7	26.70	13.4	25.40	20.62	7.9
0.625	15.8	30.66	16.6	31.75	19.05	10.3
0.750	19.0	33.83	19.7	34.93	22.23	10.3
0.875	22.2	37.00	22.9	38.10	23.80	10.3
1.000	25.4	40.10	26.1	41.28	25.40	11.1
1.125	28.5	43.36	29.3	44.45	26.97	11.1
1.250	31.7	48.13	32.4	47.63	26.97	11.1
1.375	34.9	51.30	35.6	50.80	28.58	11.1
1.500	38.1	54.48	38.8	53.98	28.58	11.1
1.625	41.2	60.83	42.4	60.33	34.93	12.7
1.750	44.4	64.00	45.5	63.50	34.93	12.7
1.875	47.6	66.68	48.7	66.68	34.93	12.7
2.000	50.8	70.36	51.9	69.85	34.93	12.7
2.125	53.9	76.70	55.0	76.20	42.85	14.3
2.250	57.1	79.88	58.2	79.38	42.85	14.3
2.375	60.3	83.06	61.4	82.55	42.85	14.3
2.500	63.5	86.23	64.6	85.73	42.85	14.3
2.625	66.6	89.40	67.7	85.73	42.85	15.9
2.750	69.8	92.58	70.9	88.90	42.85	15.9
2.875	73.0	95.76	74.1	95.25	42.85	15.9
3.000	76.2	97.33	77.3	98.43	42.85	15.9
3.125	79.3	100.50	80.5	101.60	42.85	19.8
3.250	82.5	105.28	83.6	104.78	42.85	19.8
3.375	85.7	108.46	86.8	107.95	42.85	19.8
3.500	88.9	111.63	90.0	111.13	42.85	19.8
3.625	92.0	114.80	93.1	114.30	42.85	19.8
3.750	95.2	117.98	96.3	117.48	42.85	19.8
3.875	98.4	121.16	99.5	120.65	42.85	19.8
4.000	101.6	124.33	102.7	123.83	42.85	19.8

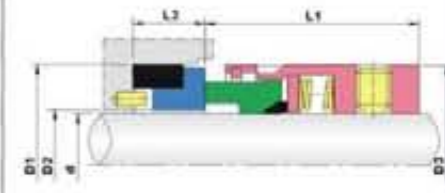

STOCK MATERIALS AND FACE MATERIAL CODE	
Rotary Face	Stationary Face
CAR	SIC
SIC	SIC
Elastomers: PTFE	

TB9



TB9B

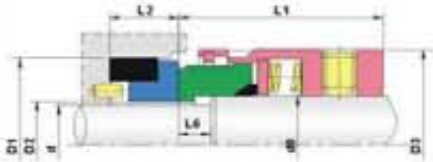

STOCK MATERIALS AND FACE MATERIAL CODE	
Rotary Face	Stationary Face
CAR	SIC
SIC	SIC
Elastomers: PTFE	

规格/Size (英寸/Inch)	d0	d	D3	D2	D1	L1	L2	L6
1.000	25.4	22.2	40.10	22.9	38.10	33.32	10.30	6.40
1.125	28.5	25.4	43.36	26.1	41.28	34.93	11.10	7.90
1.250	31.7	28.5	48.13	29.3	44.45	34.93	11.10	7.90
1.375	34.9	28.5	51.30	29.3	44.45	36.50	11.10	8.70
1.500	38.1	31.7	54.48	32.4	47.63	36.50	11.10	8.70
1.625	41.2	34.9	60.83	35.6	50.80	44.45	11.10	8.70
1.750	44.4	38.1	64.00	38.8	53.98	44.45	11.10	9.50
1.875	47.6	41.2	66.68	42.4	60.33	44.45	12.70	9.50
2.000	50.8	44.4	70.36	45.5	63.50	44.45	12.70	9.50
2.125	53.9	47.6	76.70	48.7	66.68	52.37	12.70	11.10
2.250	57.1	50.8	79.88	51.9	69.85	52.37	12.70	11.10
2.375	60.3	53.9	83.06	55.0	76.20	52.37	14.30	11.10
2.500	63.5	57.1	86.23	58.2	79.38	52.37	14.30	11.10
2.625	66.6	60.3	89.40	61.4	82.55	52.37	14.30	11.10
2.750	69.8	63.5	92.58	64.6	85.73	52.37	14.30	11.10
2.875	73.0	66.6	95.76	67.7	85.73	52.37	15.90	11.10
3.000	76.2	69.8	97.33	70.9	88.90	52.37	15.90	11.10
3.125	79.3	73.0	100.50	74.1	95.25	52.37	15.90	11.10
3.250	82.5	76.2	105.28	77.3	98.43	52.37	15.90	14.30
3.375	85.7	79.3	108.46	80.5	101.60	52.37	19.80	14.30
3.500	88.9	82.5	111.63	83.6	104.78	52.37	19.80	14.30
3.625	92.0	85.7	114.80	86.8	107.95	52.37	19.80	14.30
3.750	95.2	88.9	117.98	90.0	111.13	52.37	19.80	14.30
3.875	98.4	92.0	121.16	93.1	114.30	52.37	19.80	14.30
4.000	101.6	95.2	124.33	96.3	117.48	52.37	19.80	14.30

TB9T

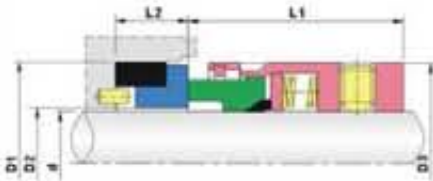

STOCK MATERIALS AND FACE MATERIAL CODE	
Rotary Face	Stationary Face
CAR	SIC
SIC	SIC
Elastomers: PTFE	

规格/Size (英寸/Inch)	d	D3	D2	D1	L1	L2
0.500	12.7	23.80	13.4	25.40	23.80	7.9
0.625	15.8	26.97	16.6	31.75	23.80	10.3
0.750	19.0	30.15	19.7	34.93	23.80	10.3
0.875	22.2	33.32	22.9	38.10	23.80	10.3
1.000	25.4	36.50	26.1	41.28	25.40	11.1
1.125	28.5	39.67	29.3	44.45	25.40	11.1
1.250	31.7	42.85	32.4	47.63	25.40	11.1
1.375	34.9	49.20	35.6	50.80	34.93	11.1
1.500	38.1	49.20	38.8	53.98	28.58	11.1
1.625	41.2	57.15	42.4	60.33	29.36	12.7
1.750	44.4	58.72	45.5	63.50	34.93	12.7
1.875	47.6	63.50	48.7	66.68	34.93	12.7
2.000	50.8	66.68	51.9	69.85	34.93	12.7
2.125	53.9	71.42	55.0	76.20	42.85	14.3
2.250	57.1	72.21	58.2	79.38	34.93	14.3
2.375	60.3	76.20	61.4	82.55	42.85	14.3
2.500	63.5	79.38	64.6	85.73	34.93	14.3
2.625	66.6	82.55	67.7	85.73	42.85	15.9
2.750	69.8	85.73	70.9	88.90	42.85	15.9
2.875	73.0	88.90	74.1	95.25	42.85	15.9
3.000	76.2	92.08	77.3	98.43	42.85	15.9
3.125	79.3	95.25	80.5	101.60	42.85	19.8
3.250	82.5	98.43	83.6	104.78	42.85	19.8
3.375	85.7	101.60	86.8	107.95	42.85	19.8
3.500	88.9	104.78	90.0	111.13	42.85	19.8
3.625	92.0	107.95	93.1	114.30	42.85	19.8
3.750	95.2	111.13	96.3	117.48	42.85	19.8
3.875	98.4	114.30	99.5	120.65	42.85	19.8
4.000	101.6	117.48	102.7	123.83	42.85	19.8

TB9BT

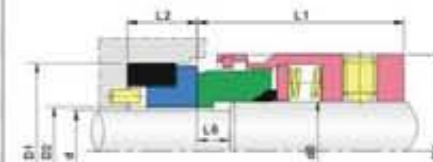

STOCK MATERIALS AND FACE MATERIAL CODE	
Rotary Face	Stationary Face
CAR	SIC
SIC	SIC
Elastomers: PTFE	

规格/Size (英寸/Inch)	d0	d	D3	D2	D1	L1	L2	L6
1.000	25.4	22.2	36.50	22.9	38.10	33.32	10.30	8.70
1.125	28.5	25.4	39.67	26.1	41.28	34.93	11.10	8.70
1.250	31.7	28.5	42.85	29.3	44.45	34.93	11.10	8.70
1.375	34.9	28.5	49.20	29.3	44.45	42.85	11.10	8.70
1.500	38.1	31.7	49.20	32.4	47.63	36.50	11.10	8.70
1.625	41.2	34.9	57.15	35.6	50.80	40.46	11.10	11.10
1.750	44.4	38.1	58.72	38.8	53.98	44.45	11.10	11.10
1.875	47.6	41.2	63.50	42.4	60.33	44.45	12.70	11.10
2.000	50.8	44.4	66.68	45.5	63.50	44.45	12.70	11.10
2.125	53.9	47.6	71.42	48.7	66.68	52.37	12.70	12.70
2.250	57.1	50.8	72.21	51.9	69.85	44.45	12.70	12.70
2.375	60.3	53.9	76.20	55.0	76.20	52.37	14.30	12.70
2.500	63.5	57.1	79.38	58.2	79.38	44.45	14.30	12.70
2.625	66.6	60.3	82.55	61.4	82.55	52.37	14.30	12.70
2.750	69.8	63.5	85.73	64.6	85.73	52.37	14.30	12.70
2.875	73.0	66.6	88.90	67.7	85.73	52.37	15.90	12.70
3.000	76.2	69.8	92.08	70.9	88.90	52.37	15.90	12.70
3.125	79.3	73.0	95.25	74.1	95.25	52.37	15.90	14.30
3.250	82.5	76.2	98.43	77.3	98.43	52.37	15.90	14.30
3.375	85.7	79.3	101.60	80.5	101.60	52.37	19.80	14.30
3.500	88.9	82.5	104.78	83.6	104.78	52.37	19.80	14.30
3.625	92.0	85.7	107.95	86.8	107.95	52.37	19.80	14.30
3.750	95.2	88.9	111.13	90.0	111.13	52.37	19.80	14.30
3.875	98.4	92.0	114.30	93.1	114.30	52.37	19.80	14.30
4.000	101.6	95.2	117.48	96.3	117.48	52.37	19.80	14.30

TB59B

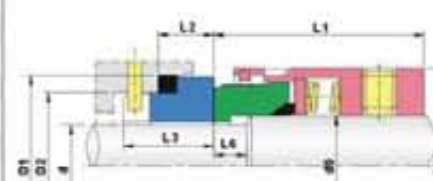

STOCK MATERIALS AND FACE MATERIAL CODE	
Rotary Face	Stationary Face
CAR	SIC
SIC	SIC
Elastomers: PTFE	

规格/Size (公制/Metric)	d0	d	D3	D2	D1	L1	L2	L3	L6
14	18	14	32	21	25	30.5	12.0	18.5	6.0
16	20	16	34	23	27	30.5	12.0	18.5	6.0
18	22	18	36	27	33	31.5	13.5	20.5	6.5
20	24	20	38	29	35	31.5	13.5	20.5	6.5
22	26	22	40	31	37	31.5	13.5	20.5	6.5
24	28	24	42	33	39	34.2	13.3	20.3	6.7
25	30	25	44	34	40	34.5	13.0	20.0	7.0
28	33	28	47	37	43	37.5	12.5	19.5	7.5
30	35	30	49	39	45	38.0	12.0	19.0	8.0
32	38	32	54	42	48	38.0	12.0	19.0	8.0
33	38	33	54	42	48	38.0	12.0	19.0	8.0
35	40	35	56	44	50	38.0	12.0	19.0	8.0
38	43	38	59	49	56	39.5	13.0	20.0	10.0
40	45	40	61	51	58	39.5	13.0	20.0	10.0
43	48	43	64	54	61	39.5	13.0	20.0	10.0
45	50	45	66	56	63	39.5	13.0	20.0	10.0
48	53	48	69	59	66	39.5	13.0	20.0	10.0
50	55	50	71	62	70	44.0	13.5	20.5	11.5
53	58	53	78	65	73	44.0	13.5	20.5	11.5
55	60	55	80	67	75	44.0	13.5	20.5	11.5
58	63	58	83	70	78	49.0	13.5	20.5	11.5
60	65	60	85	72	80	49.0	13.5	20.5	11.5
63	68	63	88	75	83	49.0	13.5	20.5	11.5
65	70	65	90	77	85	49.0	13.5	20.5	11.5
70	75	70	95	83	92	55.5	14.5	21.5	13.5
75	80	75	104	88	97	55.5	14.5	21.5	13.5
80	85	80	109	95	105	55.0	15.0	22.0	13.0
85	90	85	114	100	110	60.0	15.0	22.0	13.0
90	95	90	119	105	115	60.0	15.0	22.0	13.0
95	100	95	124	110	120	60.0	15.0	22.0	13.0
100	105	100	129	115	125	60.0	15.0	22.0	13.0



TB59U



STOCK MATERIALS AND FACE MATERIAL CODE	
Rotary Face	Stationary Face
CAR	SIC
SIC	SIC
Elastomers: PTFE	

规格/Size (公制/Metric)	d	D3	D2	D1	L1	L2	L3
14	14	24	21	25	23.0	12.0	18.5
16	16	26	23	27	23.0	12.0	18.5
18	18	32	27	33	24.0	13.5	20.5
20	20	34	29	35	24.0	13.5	20.5
22	22	36	31	37	24.0	13.5	20.5
24	24	38	33	39	26.7	13.3	20.3
25	25	39	34	40	27.0	13.0	20.0
28	28	42	37	43	30.0	12.5	19.5
30	30	44	39	45	30.5	12.0	19.0
32	32	46	42	48	30.5	12.0	19.0
33	33	47	42	48	30.5	12.0	19.0
35	35	49	44	50	30.5	12.0	19.0
38	38	54	49	56	32.0	13.0	20.0
40	40	56	51	58	32.0	13.0	20.0
43	43	59	54	61	32.0	13.0	20.0
45	45	61	56	63	32.0	13.0	20.0
48	48	64	59	66	32.0	13.0	20.0
50	50	66	62	70	34.0	13.5	20.5
53	53	69	65	73	34.0	13.5	20.5
55	55	71	67	75	34.0	13.5	20.5
58	58	78	70	78	39.0	13.5	20.5
60	60	80	72	80	39.0	13.5	20.5
63	63	83	75	83	39.0	13.5	20.5
65	65	85	77	85	39.0	13.5	20.5
68	68	88	81	90	39.0	13.5	20.5
70	70	90	83	92	45.5	14.5	21.5
75	75	95	88	97	45.5	14.5	21.5
80	80	104	95	105	45.0	15.0	22.0
85	85	109	100	110	45.0	15.0	22.0
90	90	114	106	115	50.0	15.0	22.0
95	95	119	110	120	50.0	15.0	22.0
100	100	124	115	125	50.0	15.0	22.0

TBL9

规格/Size (公制/Metric)	L1	D4	D5	规格/Size Inches	L1	D4	D5
20.0	27.91	45.3	59.8	0.625"	1.098	1.622	2.192
22.0	27.91	47.3	61.8	0.750"	1.098	1.747	2.317
24.0	27.90	49.3	63.8	0.875"	1.098	1.872	2.442
25.0	27.90	50.3	64.8	1.000"	1.098	1.997	2.567
28.0	27.91	53.3	67.8	1.125"	1.098	2.122	2.692
30.0	27.91	55.3	69.8	1.250"	1.098	2.247	2.817
32.0	27.91	57.3	71.8	1.375"	1.098	2.372	2.942
33.0	27.90	58.3	72.8	1.500"	1.098	2.497	2.067
35.0	27.91	60.3	74.8	1.625"	1.098	2.622	3.192
38.0	27.91	63.3	77.8	1.750"	1.098	2.747	3.317
40.0	27.91	65.3	79.8	1.875"	1.098	2.872	3.442
42.0	27.90	67.3	81.8	2.000"	1.098	2.997	3.567
43.0	27.90	68.3	82.8	2.125"	1.098	3.122	3.692
45.0	27.91	70.3	84.8	2.250"	1.098	3.247	3.817
48.0	27.91	73.3	87.8	2.375"	1.098	3.372	3.942
50.0	27.90	75.3	89.8	2.500"	1.098	3.497	4.067
53.0	27.91	78.3	92.8	2.625"	1.192	3.866	4.436
55.0	27.90	80.3	94.8	2.750"	1.192	3.911	4.561
60.0	27.91	85.3	99.7	2.875"	1.192	4.116	4.686
65.0	30.30	96.5	111.0	3.000"	1.192	4.241	4.811
70.0	30.28	101.5	116.0	3.125"	1.192	4.366	4.936
75.0	30.28	106.5	121.0	3.250"	1.192	4.491	5.061
80.0	30.28	111.5	126.0	3.375"	1.192	4.616	5.186
85.0	30.28	116.5	131.0	3.500"	1.192	4.741	5.311
90.0	30.28	121.5	136.0	2.750"	1.192	4.991	5.561
95.0	30.30	126.5	141.0	2.875"	1.192	5.116	5.686
100.0	30.28	131.5	146.0	4.000"	1.192	5.241	5.811

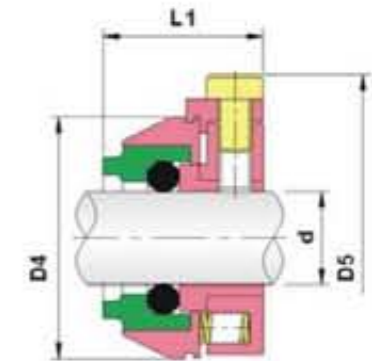

规格/Size (公制/Metric)	d0	D6	D4		D5	L	L2	L1	W	M	G
	h7		MIN	MAX							
25	25	43.0	44.0	51.5	105	67	67	25.4	62	13.2	1/4"
28	28	46.0	47.0	52.0	105	67	67	25.4	62	13.2	1/4"
30	30	48.0	49.0	56.0	105	67	67	25.4	65	13.2	1/4"
32	32	49.8	51.0	57.0	108	67	67	25.4	67	13.2	1/4"
33	33	49.8	51.0	57.0	108	67	67	25.4	67	13.2	1/4"
35	35	53.0	54.0	61.5	113	67	67	25.4	70	13.2	1/4"
38	38	56.0	57.0	66.0	123	67	67	25.4	75	13.2	1/4"
40	40	58.0	59.0	68.0	123	67	67	25.4	75	14.2	3/8"
42	42	60.5	61.5	69.5	133	67	67	25.4	80	14.2	3/8"
43	43	60.5	61.5	70.5	133	67	67	25.4	80	14.2	3/8"
45	45	62.5	64.0	73.0	138	67	67	25.4	81	14.2	3/8"
48	48	65.6	67.0	75.0	138	67	67	25.4	84	14.2	3/8"
50	50	68.0	69.0	78.0	148	67	67	25.4	87	14.2	3/8"
53	53	72.0	73.0	87.0	148	67	67	25.4	97	18.0	3/8"
55	55	73.0	74.0	83.0	148	67	67	25.4	90	18.0	3/8"
60	60	78.0	79.0	91.0	157	67	67	25.4	102	18.0	3/8"
65	65	84.8	85.7	98.5	163	67	67	25.4	109	18.0	3/8"
70	70	93.0	95.0	108.0	178	67	67	25.4	118	18.0	3/8"
75	75	100.0	101.6	118.0	190	84	84	28.0	129	18.0	3/8"
80	80	106.4	108.0	124.0	195	84	84	28.0	135	18.0	3/8"
85	85	109.5	111.1	128.0	198	84	84	28.0	139	22.0	3/8"
90	90	115.9	117.5	135.0	205	84	84	28.0	145	22.0	3/8"
95	95	119.1	120.7	138.0	208	84	84	28.0	148	22.0	3/8"
100	100	125.4	127.0	144.0	218	84	84	28.0	154	22.0	3/8"

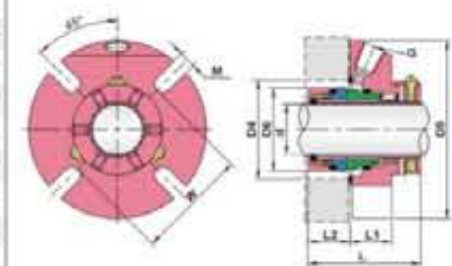



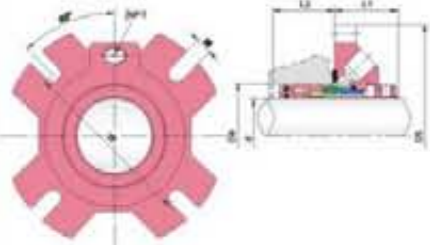

规格/Size (公制/Metric)	D4		D5	L1	L2	W		M
	MIN	MAX				MIN	MAX	
24	40.0	49.2	104.8	37.5	32.0	66.7	95.3	11.1
25	41.0	49.2	104.8	37.5	32.0	66.7	95.3	11.1
28	44.0	52.4	108.0	37.5	32.0	69.9	98.4	11.1
30	46.0	55.6	111.0	37.5	32.0	73.0	101.6	11.1
32	47.6	55.6	111.0	37.5	32.0	73.0	101.6	11.1
33	49.0	58.7	114.3	37.5	32.0	77.8	104.8	11.1
35	50.8	58.7	114.3	37.5	32.0	77.8	104.8	11.1
38	57.2	63.5	127.0	38.5	33.0	87.3	114.3	14.3
40	60.0	63.5	127.0	38.5	33.0	87.3	114.3	14.3
43	63.0	66.7	133.4	38.5	33.0	90.5	120.7	14.3
45	63.5	66.7	133.4	38.5	33.0	90.5	120.7	14.3
48	66.7	76.2	139.7	38.5	33.0	98.4	127.0	14.3
50	69.8	76.2	139.7	38.5	33.0	98.4	127.0	14.3
53	73.0	84.1	146.0	38.5	33.0	111.1	130.2	17.5
55	73.0	84.1	146.0	38.5	33.0	111.1	130.2	17.5
58	79.4	90.5	152.4	38.5	33.0	117.5	136.5	17.5
60	79.4	90.5	152.4	38.5	33.0	117.5	136.5	17.5
63	82.6	98.4	158.8	39.0	36.0	123.8	142.9	17.5
65	88.9	98.4	158.8	39.0	36.0	123.8	142.9	17.5
70	95.0	98.4	158.8	39.0	36.0	123.8	142.9	17.5
75	101.6	114.3	206.0	46.0	42.5	145.0	167.0	20.6
80	108.0	120.6	206.0	46.0	42.5	151.0	167.0	20.6
85	111.0	123.8	206.0	46.0	42.5	154.0	167.0	20.6
90	117.5	130.0	216.0	46.0	42.5	160.0	177.0	20.6
95	120.7	133.4	246.0	46.0	42.5	164.0	207.0	20.6
100	127.0	140.0	246.0	46.0	42.5	171.0	207.0	20.6
105	133.4	150.0	246.0	62.0	44.0	181.0	223.0	20.6
110	139.7	155.0	246.0	62.0	44.0	188.0	223.0	20.6
115	139.7	155.0	246.0	62.0	44.0	188.0	223.0	20.6
120	146.1	162.0	266.0	62.0	44.0	194.0	223.0	20.6
125	160.0	176.0	266.0	62.0	44.0	210.0	253.0	20.6
130	160.0	176.0	266.0	62.0	44.0	210.0	253.0	20.6
135	174.0	190.0	299.0	62.0	44.0	226.0	275.0	23.8
140	174.0	190.0	299.0	62.0	44.0	226.0	275.0	23.8

规格/Size (英寸/Inch)	D4		D5	L1	L2	W		M
	MIN	MAX				MIN	MAX	
1.000	1.615	1.940	4.125	1.476	1.260	2.62	3.75	0.437
1.125	1.730	2.060	4.250	1.476	1.260	2.75	3.87	0.437
1.250	1.875	2.190	4.370	1.476	1.260	2.87	4.00	0.437
1.375	2.000	2.310	4.500	1.476	1.260	3.06	4.12	0.437
1.500	2.250	2.500	5.000	1.516	1.299	3.43	4.50	0.563
1.625	2.360	2.500	5.000	1.516	1.299	3.43	4.50	0.563
1.750	2.500	2.625	5.250	1.516	1.299	3.56	4.75	0.563
1.875	2.625	3.000	5.500	1.516	1.299	3.87	5.00	0.563
2.000	2.750	3.000	5.500	1.516	1.299	3.87	5.00	0.563
2.125	2.875	3.310	5.750	1.516	1.299	4.37	5.12	0.563
2.250	3.000	3.310	5.750	1.516	1.299	4.37	5.12	0.689
2.375	3.130	3.560	6.000	1.516	1.299	4.62	5.37	0.689
2.500	3.250	3.875	6.250	1.535	1.417	4.87	5.62	0.689
2.625	3.500	3.875	6.250	1.535	1.417	4.87	5.62	0.689
2.750	3.740	3.875	6.250	1.535	1.417	4.87	5.62	0.689
2.875	4.000	4.500	8.110	1.811	1.673	5.71	6.59	0.811
3.000	4.000	4.500	8.110	1.811	1.673	5.71	6.59	0.811
3.125	4.252	4.748	8.110	1.811	1.673	5.94	6.59	0.811
3.250	4.252	4.748	8.110	1.811	1.673	5.94	6.59	0.811
3.375	4.370	4.874	8.110	1.811	1.673	6.06	6.59	0.811
3.500	4.500	5.000	8.504	1.811	1.673	6.22	6.98	0.811
3.625	4.626	5.118	8.504	1.811	1.673	6.30	6.98	0.811
3.750	4.752	5.252	9.685	1.811	1.673	6.46	8.17	0.811
3.875	4.874	5.374	9.685	1.811	1.673	6.57	8.17	0.811
4.000	5.000	5.512	9.685	1.811	1.673	6.73	8.17	0.811
4.125	5.252	5.906	9.685	2.441	1.732	7.13	8.80	0.811
4.250	5.252	5.906	9.685	2.441	1.732	7.13	8.80	0.811
4.375	5.500	6.102	9.685	2.441	1.732	7.40	8.80	0.811
4.500	5.500	6.102	9.685	2.441	1.732	7.40	8.80	0.811
4.625	5.752	6.378	10.472	2.441	1.732	7.64	8.80	0.811
4.750	5.752	6.378	10.472	2.441	1.732	7.64	8.80	0.811
4.875	6.299	6.929	10.472	2.441	1.732	8.27	9.98	0.811
5.000	6.299	6.929	10.472	2.441	1.732	8.27	9.98	0.811
5.125	6.299	6.929	10.472	2.441	1.732	8.27	9.98	0.811
5.250	6.850	7.480	11.654	2.441	1.732	8.90	10.84	0.937
5.375	6.850	7.480	11.654	2.441	1.732	8.90	10.84	0.937
5.500	6.850	7.480	11.654	2.441	1.732	8.90	10.84	0.937
5.625	6.850	7.480	11.654	2.441	1.732	8.90	10.84	0.937

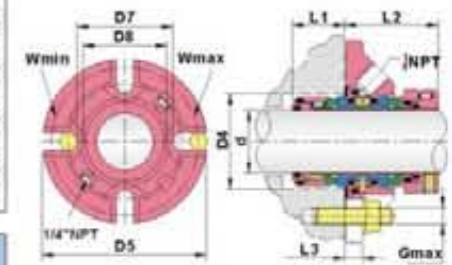

规格/Size (公制/Metric)	D5	D7	D8	L3	D4		W		M	L1	L2
					MIN	MAX	MIN	MAX			
24	104.8	54.0	49.2	13.2	40.0	46.0	67.0	90.5	12	32.5	52.4
25	104.8	54.0	49.2	13.2	41.0	49.0	67.0	90.5	12	32.5	52.4
28	108.0	57.2	52.4	13.2	44.0	52.3	70.3	93.6	12	32.5	52.4
30	111.0	60.4	55.6	13.2	46.0	55.5	73.5	96.8	12	32.5	52.4
32	111.0	60.4	55.6	13.2	48.0	55.5	73.5	96.8	12	32.5	52.4
33	111.0	60.4	55.6	13.2	49.0	55.5	73.5	96.8	12	32.5	52.4
35	111.0	63.5	58.8	13.2	51.0	57.5	76.6	96.8	12	32.5	54.0
38	127.0	71.5	65.0	16.4	57.2	60.3	85.7	114.3	12	33.3	54.0
40	127.0	71.5	65.0	16.4	58.0	60.4	85.7	114.3	12	33.3	54.0
43	127.0	71.5	65.0	16.4	61.0	63.5	85.7	114.3	12	33.3	54.0
45	139.7	81.0	71.4	16.4	63.5	69.9	95.3	127.0	12	33.3	54.0
48	139.7	81.0	71.4	16.4	66.7	73.0	95.3	127.0	12	33.3	54.0
50	139.7	81.0	71.4	16.4	68.0	73.0	95.3	127.0	12	33.3	54.0
53	152.4	90.5	77.8	16.4	71.0	76.0	104.8	139.7	12	35.0	54.0
55	152.4	90.5	77.8	16.4	74.0	79.4	104.8	139.7	12	35.0	54.0
58	165.1	96.8	84.1	16.4	76.2	82.5	114.3	149.2	16	35.0	54.0
60	165.1	96.8	84.1	16.4	79.4	85.7	114.3	149.2	16	35.0	54.0
63	177.8	109.5	96.8	19.6	85.8	92.1	127.0	160.3	16	38.1	60.3
65	177.8	109.5	96.8	19.6	88.9	95.3	127.0	160.3	16	38.1	60.3
68	177.8	109.5	96.8	19.6	92.1	98.4	127.0	160.3	16	38.1	60.3
70	177.8	109.5	96.8	19.6	92.1	98.4	127.0	160.3	16	38.1	60.3
75	190.5	125.4	108.0	19.6	98.5	108.0	142.9	173.0	16	38.1	60.3
80	190.5	125.4	108.0	19.6	101.6	111.1	142.9	173.0	16	38.1	60.3
85	203.2	135.0	117.5	19.6	108.0	117.5	155.6	182.5	20	38.1	60.3
90	215.9	150.8	127.0	19.6	114.3	127.0	171.5	195.2	20	38.1	60.3
95	215.9	150.8	127.0	19.6	117.5	130.2	171.5	195.2	20	38.1	60.3
100	228.6	168.3	136.5	19.6	123.9	139.7	189.0	208.0	20	38.1	60.3
105	228.6	168.3	136.5	19.6	130.1	149.2	189.0	208.0	20	38.1	60.3
110	241.3	177.8	146.2	19.6	136.5	158.8	198.4	220.6	20	38.1	60.3
115	254.0	186.6	155.8	19.6	142.9	168.3	211.1	230.2	23	38.1	60.3
120	254.0	186.6	155.8	19.6	142.9	168.3	211.1	230.2	23	38.1	60.3
125	254.0	186.6	155.8	19.6	149.2	168.3	211.1	230.2	23	38.1	60.3

规格/Size (英寸/Inch)	D5	D7	D8	L3	D4		W		G	L1	L2
					MIN	MAX	MIN	MAX			
1.000	4.125	2.125	1.937	0.591	1.625	1.937	2.687	3.562	1/2	1.281	2.062
1.125	4.250	2.250	2.063	0.591	1.750	2.062	2.812	3.617	1/2	1.281	2.062
1.250	4.375	2.375	2.187	0.591	1.875	2.187	2.937	3.812	1/2	1.281	2.062
1.375	4.375	2.500	2.312	0.591	2.000	2.250	3.062	3.812	1/2	1.281	2.062
1.500	5.000	2.812	2.562	0.644	2.250	2.375	3.375	4.437	1/2	1.312	2.125
1.625	5.000	2.812	2.562	0.644	2.375	2.500	3.375	4.437	1/2	1.312	2.125
1.750	5.500	3.187	2.812	0.644	2.500	2.750	3.750	4.937	1/2	1.312	2.125
1.875	5.500	3.187	2.812	0.644	2.625	2.875	3.750	4.937	1/2	1.312	2.125
2.000	6.000	3.562	3.								



TBGU1

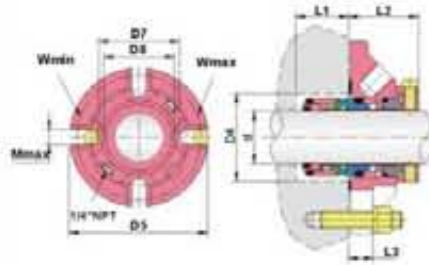

规格/Size (公制/Metric)	D5	D7	D8	L3	D4		W		M	L1	L2
					MIN	MAX	MIN	MAX			
24	104.8	54.0	49.2	13.2	40.0	46.0	67.0	90.5	12	28.6	40.5
25	104.8	54.0	49.2	13.2	41.0	49.0	67.0	90.5	12	28.6	40.5
28	108.0	57.2	52.4	13.2	44.0	52.3	70.3	93.6	12	28.6	40.5
30	111.0	60.4	55.6	13.2	46.0	55.5	73.5	96.8	12	28.6	40.5
32	111.0	60.4	55.6	13.2	48.0	55.5	73.5	96.8	12	28.6	40.5
33	111.0	60.4	55.6	13.2	49.0	55.5	73.5	96.8	12	28.6	40.5
35	111.0	63.5	58.8	13.2	51.0	57.5	76.6	96.8	12	28.6	40.5
38	127.0	71.5	65.0	16.4	57.2	60.4	85.7	114.3	12	28.6	44.5
40	127.0	71.5	65.0	16.4	58.0	60.4	85.7	114.3	12	28.6	44.5
43	139.7	81.0	71.4	16.4	61.0	69.9	95.3	127.0	12	28.6	44.5
45	139.7	81.0	71.4	16.4	63.5	69.9	95.3	127.0	12	28.6	44.5
48	139.7	81.0	71.4	16.4	66.7	73.0	95.3	127.0	12	28.6	44.5
50	152.4	90.5	77.8	16.4	68.0	76.2	104.8	139.7	12	28.6	44.5
53	152.4	90.5	77.8	16.4	71.0	76.2	104.8	139.7	12	28.6	44.5
55	165.1	96.8	84.1	16.4	74.0	82.5	114.3	149.2	16	28.6	44.5
58	165.1	96.8	84.1	16.4	76.2	82.6	114.3	149.2	16	28.6	44.5
60	165.1	96.8	84.1	16.4	79.4	85.7	114.3	149.2	16	28.6	44.5
63	177.8	109.5	96.8	19.6	85.8	92.1	127.0	160.3	16	31.8	47.7
65	177.8	109.5	96.8	19.6	88.9	95.3	127.0	160.3	16	31.8	47.7
68	177.8	109.5	96.8	19.6	92.1	98.4	127.0	160.3	16	31.8	47.7
70	177.8	109.5	96.8	19.6	92.1	98.4	127.0	160.3	16	31.8	47.7
75	190.5	125.4	108.0	19.6	98.5	108.0	142.9	173.0	16	31.8	47.7
80	190.5	125.4	108.0	19.6	101.6	111.1	142.9	173.0	16	31.8	47.7
85	203.2	135.0	117.5	19.6	108.0	117.5	155.6	182.5	20	31.8	47.7
90	215.9	150.8	127.0	19.6	114.3	127.0	171.5	195.2	20	31.8	47.7
95	215.9	150.8	127.0	19.6	117.5	130.2	171.5	195.2	20	31.8	47.7
100	228.6	168.3	136.5	19.6	123.9	139.7	188.9	207.9	20	31.8	47.7
105	228.6	168.3	136.5	19.6	130.1	149.2	189.0	208.0	20	31.8	47.7
110	241.3	177.8	146.1	19.6	136.5	158.8	198.4	220.6	20	31.8	47.7
115	254.0	186.6	155.6	19.6	142.9	168.3	211.1	230.2	22	31.8	47.7
120	254.0	186.6	155.6	19.6	142.9	168.3	211.1	230.2	22	31.8	47.7
125	254.0	186.6	155.6	19.6	142.9	168.3	211.1	230.2	22	31.8	47.7

规格/Size (英寸/Inch)	D5	D7	D8	L3	D4		W		M	L1	L2
					MIN	MAX	MIN	MAX			
1.000	4.125	2.125	1.937	0.519	1.625	1.937	2.687	3.562	1/2	1.125	1.590
1.125	4.250	2.250	2.063	0.519	1.750	2.062	2.812	3.687	1/2	1.125	1.590
1.250	4.375	2.375	2.187	0.519	1.875	2.187	2.937	3.812	1/2	1.125	1.590
1.375	4.375	2.500	2.312	0.519	2.000	2.250	3.062	3.812	1/2	1.125	1.590
1.500	5.000	2.812	2.562	0.644	2.250	2.375	3.375	4.437	1/2	1.125	1.752
1.625	5.000	2.812	2.562	0.644	2.375	2.500	3.375	4.437	1/2	1.125	1.752
1.750	5.500	3.187	2.812	0.644	2.500	2.750	3.750	4.937	1/2	1.125	1.752
1.875	5.500	3.187	2.812	0.644	2.625	2.875	3.750	4.937	1/2	1.125	1.752
2.000	6.000	3.562	3.063	0.644	2.750	3.000	4.125	5.437	1/2	1.125	1.752
2.000-AC	5.250	3.450	3.035	0.644	2.750	3.000	4.000	4.750	1/2	1.125	1.752
2.125	6.000	3.562	3.063	0.644	2.875	3.125	4.125	5.437	1/2	1.125	1.752
2.250	6.500	3.812	3.312	0.644	3.000	3.250	4.500	5.812	5/8	1.125	1.752
2.375	6.500	3.812	3.312	0.644	3.125	3.375	4.500	5.812	5/8	1.125	1.752
2.500	7.000	4.312	3.812	0.769	3.375	3.625	5.000	6.312	5/8	1.250	1.877
2.625	7.000	4.312	3.812	0.769	3.500	3.750	5.000	6.312	5/8	1.250	1.877
2.750	7.000	4.312	3.812	0.769	3.625	3.875	5.000	6.312	5/8	1.250	1.877
2.875	7.500	4.937	4.250	0.769	3.750	4.125	5.625	6.812	5/8	1.250	1.877
3.000	7.500	4.937	4.250	0.769	3.875	4.250	5.625	6.812	5/8	1.250	1.877
3.125	7.500	4.937	4.250	0.769	4.000	4.375	5.625	6.812	5/8	1.250	1.877
3.250	8.000	5.312	4.625	0.769	4.125	4.500	6.125	7.187	3/4	1.250	1.877
3.375	8.000	5.312	4.625	0.769	4.250	4.625	6.125	7.187	3/4	1.250	1.877
3.500	8.000	5.312	4.625	0.769	4.375	4.750	6.125	7.187	3/4	1.250	1.877
3.625	8.500	5.937	5.000	0.769	4.500	5.000	6.750	7.687	3/4	1.250	1.877
3.750	8.500	5.937	5.000	0.769	4.625	5.125	6.750	7.687	3/4	1.250	1.877
3.875	8.500	5.937	5.000	0.769	4.750	5.250	6.750	7.687	3/4	1.250	1.877
4.000	9.000	6.625	5.375	0.769	4.875	5.500	7.437	8.187	3/4	1.250	1.877
4.125	9.000	6.625	5.375	0.769	5.125	5.875	7.437	8.187	3/4	1.250	1.877
4.250	9.000	6.625	5.375	0.769	5.125	5.875	7.437	8.187	3/4	1.250	1.877
4.375	9.500	7.000	5.750	0.769	5.375	6.250	7.812	8.687	3/4	1.250	1.877
4.500	9.500	7.000	5.750	0.769	5.375	6.250	7.812	8.687	3/4	1.250	1.877
4.625	10.000	7.345	6.125	0.769	5.625	6.625	8.312	9.062	7/8	1.250	1.877
4.750	10.000	7.345	6.125	0.769	5.625	6.625	8.312	9.062	7/8	1.250	1.877
4.875	10.000	7.345	6.125	0.769	5.875	6.625	8.312	9.062	7/8	1.250	1.877
5.000	10.000	7.345	6.125	0.769	5.875	6.625	8.312	9.062	7/8	1.250	1.877

TBGU2

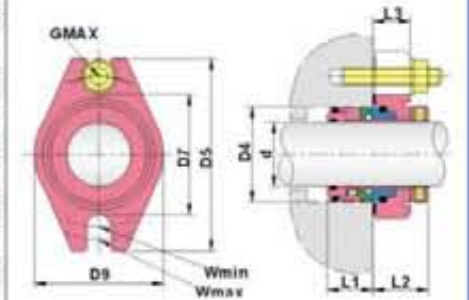

规格/Size (公制/Metric)	D5	D7	L3	D9	D4		W		G	L1	L2
					MIN	MAX	MIN	MAX			
24	101.6	55.6	20.7	56.1	40.0	48.0	69.9	88.9	12	28.6	31.8
25	101.6	55.6	20.7	56.1	41.0	48.0	69.9	88.9	12	28.6	31.8
28	104.8	58.8	20.7	59.3	44.0	50.0	73.1	92.1	12	28.6	31.8
30	108.0	61.9	20.7	62.4	46.0	54.0	76.2	95.3	12	28.6	31.8
32	108.0	61.9	20.7	62.4	48.0	54.0	76.2	95.3	12	28.6	31.8
33	108.0	61.9	20.7	62.4	49.0	55.0	76.2	95.3	12	28.6	31.8
35	108.0	66.7	20.7	67.2	51.0	59.0	81.0	95.3	12	28.6	31.8
38	114.3	71.5	22.3	72.0	57.2	62.0	85.8	101.6	12	28.6	33.4
40	114.3	71.5	22.3	72.0	58.0	64.0	85.8	101.6	12	28.6	33.4
43	120.7	74.6	22.3	75.1	61.0	67.0	88.9	108.0	12	28.6	33.4
45	127.0	77.8	23.8	78.3	63.5	69.0	92.1	114.3	12	30.2	35.0
48	133.4	81.0	23.8	81.5	66.7	72.0	95.3	120.7	12	30.2	35.0
50	133.4	81.0	23.8	81.5	68.0	74.0	95.3	120.7	12	30.2	35.0
53	139.7	84.2	25.4	84.7	71.0	77.0	101.6	123.9	16	30.2	36.5
55	146.1	87.3	25.4	87.8	74.0	79.0	104.8	130.2	16	30.2	36.5
58	165.1	95.3	25.4	98.9	79.4	85.7	115.9	146.0	20	30.2	36.5
60	165.1	95.3	25.4	98.9	79.4	85.7	115.9	146.0	20	30.2	36.5
63	177.8	111.2	25.4	121.2	85.8	101.6	131.8	158.7	20	28.6	41.2
65	177.8	111.2	25.4	121.2	88.9	101.6	131.8	158.7	20	28.6	41.2
68	177.8	111.2	25.4	121.2	92.1	101.6	131.8	158.7	20	28.6	41.2
70	177.8	111.2	25.4	121.2	92.1	101.6	131.8	158.7	20	28.6	41.2
75	190.5	125.4	31.7	130.7	98.5	114.3	146.1	171.4	20	30.2	50.8
80	190.5	125.4	31.7	130.7	101.6	114.3	146.1	171.4	20	30.2	50.8
85	203.2	135.0	31.7	140.2	108.0	123.8	155.6	184.1	20	30.2	50.8
90	215.9	144.5	31.7	149.7	114.3	133.3	165.1	196.8	20	30.2	50.8
95	215.9	144.5	31.7	149.7	117.3	133.3	165.1	196.8	20	30.2	50.8
100	228.6	154.0	31.7	156.1	123.9	139.7	174.7	209.5	20	30.2	50.8

规格/Size (英寸/Inch)	D5	D7	L3	D9	D4		W		G	L1	L2
					MIN	MAX	MIN	MAX			
1.000	4.000	2.187	0.812	2.208	1.625	1.875	2.750	3.500	1/2	1.125	1.250
1.125	4.125	2.312	0.812	2.333	1.750	2					



TB685

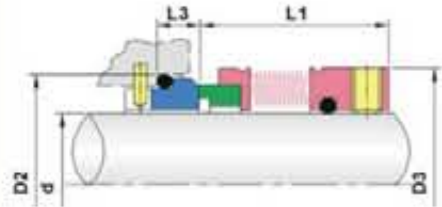

规格/Size (公制/Metric)	d	D3	D2	L3	L1
16	16	30.00	27.0	10.0	32.5
18	18	32.00	33.0	11.5	30.5
20	20	33.50	35.0	11.5	30.5
22	22	36.50	37.0	11.5	30.5
24	24	39.00	39.0	11.5	28.5
25	25	39.60	40.0	11.5	28.5
28	28	42.80	43.0	11.5	31.0
30	30	45.00	45.0	11.5	31.0
32	32	46.00	48.0	11.5	31.0
33	33	48.00	48.0	11.5	31.0
35	35	49.20	50.0	11.5	31.0
38	38	52.30	56.0	14.0	31.0
40	40	55.50	58.0	14.0	31.0
43	43	57.50	61.0	14.0	31.0
45	45	58.70	63.0	14.0	31.0
48	48	61.90	66.0	14.0	31.0
50	50	65.00	70.0	15.0	32.5
53	53	68.20	73.0	15.0	32.5
55	55	70.00	75.0	15.0	32.5
58	58	71.70	78.0	15.0	37.5
60	60	74.60	80.0	15.0	37.5
63	63	79.00	83.0	15.0	37.5
65	65	84.10	85.0	15.0	37.5
68	68	87.30	90.0	18.0	34.5
70	70	87.30	92.0	18.0	42.0
75	75	95.00	97.0	18.0	42.0
80	80	98.40	105.0	18.2	41.8
85	85	104.70	110.0	18.2	41.8
90	90	111.00	115.0	18.2	46.8
95	95	114.00	120.0	17.2	47.8
100	100	117.40	125.0	17.2	47.8

TB686

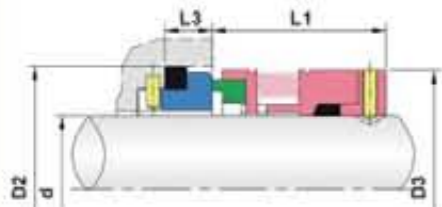

规格/Size (公制/Metric)	d	D3	D2	L3	L1
16	16	38.0	35.0	11.5	46.7
18	18	40.0	37.0	11.5	46.7
20	20	42.0	40.0	11.5	46.7
22	22	44.0	43.0	11.5	46.7
24	24	46.0	43.0	11.5	46.7
25	25	47.0	45.0	11.5	46.7
28	28	50.0	48.0	11.5	46.7
30	30	52.0	50.0	11.5	46.7
32	32	54.0	56.0	14.0	46.7
33	33	55.0	56.0	14.0	46.7
35	35	57.0	58.0	14.0	46.7
38	38	60.0	61.0	14.0	46.7
40	40	66.0	63.0	14.0	47.7
43	43	69.0	66.0	14.0	47.7
45	45	71.0	70.0	15.0	47.7
48	48	74.0	73.0	15.0	47.7
50	50	76.0	75.0	15.0	47.7
53	53	79.0	78.0	15.0	47.7
55	55	81.0	80.0	15.0	47.7
58	58	85.0	83.0	15.0	53.2
60	60	87.0	85.0	15.0	53.2
63	63	90.0	90.0	18.0	53.2
65	65	92.0	92.0	18.0	53.2
68	68	95.0	97.0	18.0	53.2
70	70	97.0	97.0	18.0	53.2
75	75	102.0	105.0	18.2	53.0
80	80	107.0	110.0	18.2	53.0
85	85	112.0	115.0	18.2	53.0
90	90	117.0	120.0	17.2	54.0
95	95	122.0	125.0	17.2	54.0
100	100	127.0	134.3	20.0	54.2

TB687

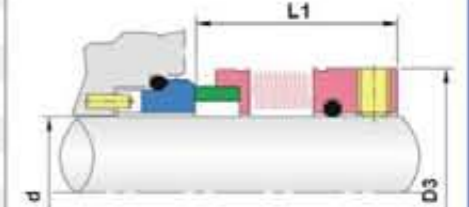

规格/Size (公制/Metric)	d	D3	L1	规格/Size (公制/Metric)	d	D3	L1
0.750	0.750	1.312	1.250	18	18	32.00	27.7
0.875	0.875	1.437	1.250	20	20	33.30	27.7
0.937	0.937	1.500	1.250	22	22	36.00	27.7
1.000	1.000	1.562	1.250	24	24	38.10	30.2
1.125	1.125	1.687	1.250	25	25	39.00	30.2
1.250	1.250	1.812	1.312	28	28	42.00	32.7
1.375	1.375	1.937	1.437	30	30	44.00	32.7
1.500	1.500	2.063	1.437	32	32	46.00	32.7
1.625	1.625	2.187	1.437	33	33	47.00	32.7
1.750	1.750	2.312	1.437	35	35	49.20	32.7
1.875	1.875	2.437	1.500	38	38	52.40	34.2
2.000	2.000	2.562	1.500	40	40	55.60	34.2
2.125	2.125	2.687	1.500	43	43	58.70	34.2
2.250	2.250	2.812	1.562	45	45	58.70	34.2
2.375	2.375	2.937	1.562	48	48	61.90	34.2
2.500	2.500	3.187	1.562	50	50	65.10	34.7
2.625	2.625	3.312	1.625	53	53	68.30	34.7
2.750	2.750	3.437	1.625	55	55	71.00	34.7
2.875	2.875	3.625	1.687	60	60	74.60	39.7
3.000	3.000	3.750	1.687	65	65	84.10	39.7
3.125	3.125	3.875	1.750	70	70	87.30	45.2
3.250	3.250	4.000	1.750	75	75	95.30	45.2
3.375	3.375	4.125	1.750	80	80	98.40	44.7
3.500	3.500	4.250	1.875	85	85	104.80	44.7
3.625	3.625	4.375	1.875	90	90	108.00	49.7
3.750	3.750	4.500	1.875	95	95	114.30	49.7
3.880	3.880	4.625	1.875				
4.000	4.000	4.750	1.875				

规格/Size (公制/Metric)	d	D3	L1
25.40	25.40	41.28	38.95
28.58	28.58	44.45	39.87
31.75	31.75	47.63	40.66
34.93	34.93	50.80	40.66
38.10	38.10	53.98	40.66
41.28	41.28	57.15	40.66
44.45	44.45	60.33	41.48
47.63	47.63	63.50	41.48
50.80	50.80	66.68	42.26
53.98	53.98	69.85	42.26
57.15	57.15	73.03	43.86
60.33	60.33	76.20	43.86
63.50	63.50	82.55	44.65
66.68	66.68	85.73	45.44
69.85	69.85	88.90	45.44
73.03	73.03	93.65	47.83
76.20	76.20	96.82	47.83
79.38	79.38	101.60	47.83
82.55	82.55	104.78	47.83
85.73	85.73	107.95	47.83
88.90	88.90	111.13	47.83
92.08	92.08	114.30	47.83
95.25	95.25	117.48	47.83
98.43	98.43	120.65	47.83
101.60	101.60	123.83	47.83

TB688

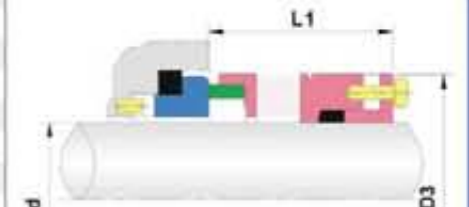





Mechanical Seal For Alfa Laval Pump	
TOPBON Type	PUMP Type
TB91-22	CM 1,1A,1B,1C,1D. GM1,1A,2,2A. EM1C,EM1D
TB91B-22	FS OS,0,1,1A,1AE,2,2A,3,3A,4 et 4A
TB92-27	MR 185,185A,200 et 200A
TB92-35	LKH 10,15,20,25,35,40,45,50 et 60
TB92A-35	Alfa Laval Pump
TB92B-35	Alfa Laval Pump
TB92-42	Alfa Laval Pump
TB92-53	Alfa Laval Pump
TBT93-22	Alfa Laval Pump
TBT93B-22	Alfa Laval Pump
TB94	Alfa Laval Pump
TBHOM2	Alfa Laval Conthem scraped surface heat exchangers



Mechanical Seal For Alfa Laval Pump	
TOPBON Type	PUMP Type
TBGLF1-12MM	GRUNDFOS CR,CR8,CR1,CRN1,CRN3,CRN5,CRNE1,CRNE3-23HS
TBGLF1-16MM	GRUNDFOS CR,CR1,CRN10,CRN15,CRN20
TBGLF2-12MM	GRUNDFOS CR,CR8,CR1,CRN1,CRN3,CRN5,CRNE1,CRNE3-23HS
TBGLF2-16MM	GRUNDFOS CR,CR1,CRN10,CRN15,CRN20
TBGLF3-22MM	GRUNDFOS CR,CRN32,CRN45,CRN64,CRN90
TBGLF4-22MM	GRUNDFOS CR,CRN32,CRN45,CRN64,CRN90
TBGLF5	GRUNDFOS Pumps
TBGLF6-12MM	GRUNDFOS Pumps
TBGLF6-16MM	GRUNDFOS Pumps
TBGLF7	GRUNDFOS Pumps
TBGLF8	GRUNDFOS Pumps
TBGLF9	GRUNDFOS Pumps
TBGLF10	GRUNDFOS Pumps
TBGLF11	GRUNDFOS Pumps





Mechanical Seal For FLYGT Pump			
FLYGT Pump Model	Shaft Size	TOPBON Upper Seal	TOPBON Lower Seal
3085-91,3085-120,3085-170,3085-171,3085-181,3085-280,3082-290,3085-890	20mm	FGU20	FGL20
3101	28mm	FBU28	FBL28
3102	25mm	FJU25	FJL25
3126-90,3126-180	35mm	FKU35	FKL35
3126-91,3126-280,3126-290	35mm	FKU35	FML35
3126-181,3127	35mm	FMU35	FML35
3140,3152	45mm	FOU45	FOL45
3170,3201	60mm	FQU60	FQL60
3200	60mm	FPU60	FPL60
3230,3300-91,3300-181,3300-280,3300-980,3305	90mm	FSU90	FSL90
3310,3311,3312,3350,3351	90mm-120mm	FSU90	FTL120
3355,3356,3357	90mm	FSU90	FSL90
3500,3501,3530,3531,3600,3601,3602	90mm-120mm	FSU90	FTL120
4351,4352,4400	20mm	FGU20	FHL20
4410,4430	60mm	/	FQL60
4440,5530	35mm	FMU35	FML35
4650,4660	45mm	FOU45	FOL45
4670,4680,7045	60mm	FQU60	FQL60
7050,7051,7055,7060,7061,7076,7556	90mm	FSU90	FSL90
7080,7115	90mm-80mm/90mm-120mm	FSU90	FSL80/FTL120
7570,7585	90mm-120mm	FSU90	FTL120
Grindex Maior,Master,Matador,Midi,Minette,Salvador	25mm-24mm	FZU25	FZL24
Grindex Maxi	45mm	FOU45	FNL45
Ready models 4 8 12 & 16	15mm	FDU15	/
Ready 24	20mm	FAU20	FAL20
Ready 90	28mm	FIU28	FIL28
Steady 7	20mm	FGU20	FGL20
600	60mm	FQU60	FQL60
605,615,665,670,680	90mm-80mm	FSU90	FSL80
705,715,720,721,735,745,760,765,770,775	90mm-80mm/90mm-120mm	FSU90	FSL80/FTL120
820,840,841,860,880,881,900	90mm-80mm/90mm-120mm	FSU90	FSL80/FTL120
2004,2008,2012,2016	15mm	FDU15	/
2024	20mm	FAU20	FAL20
2050,2052	15mm	FDU15	/
2060	20mm	FGU20	FGL20
2066	20mm	FAU20	FAL20
2070	22mm	FEU22	FEL22
2071	22mm	FEU22	FEL22
2075	20mm	FAU20	FAL20
2082,2090,2125,2140	28mm	FIU28	FIL28
2084,2135	35mm	FKU35	FKL35
2101	20mm	FAU20	FAL20
2102-40	22mm	FEU22	FEL22
2151-10	35mm	FKU35	FKL35
2151-11,2151-50	35mm	FKU35	FLL35
2201-10,2201-320,2201-430,2201-480	45mm-35mm	FOU45	FKL35
2201-590,2201-690	45mm	FOU45	FOL45
2201-11HT or MT	45mm	FNU45	FNL45
2201-11LT	45mm	FOU45	FNL45
2250,2290	60mm	FPU60	FPL60
2400	60mm	FRU60	FRL60
3041-281	20mm	FGU20	FGL20
3057	20mm	FGU20	FHL20
3057-180,3060	20mm	FGU20	FGL20
3065	20mm	FAU20	FAL20
3067-170,3067-250,3068	20mm	FGU20	FGL20
3080	20mm	FAU20	FAL20
3082	22mm	FEU22	FEL22





TOPBON FLYGT PLUG IN SEAL COMPARISON CHART			
Topbon Seal Code	Shaft Size	Material	Fits Xylem Flygt pumps / Mixers
TBJC20	20MM	TC/TC/TC/CER/VIT	2610,2620,2630,2640,4610 & 4620
TBJC25	25MM	SIC/SIC/TC/CER/VIT	2660,4630 & 4640
TBJC35	35MM	TC/TC/TC/TC/VIT	2670,3153,5100.210,5100.211,5100.220 & 5100.221
TBJC45	45MM	TC/TC/TC/TC/VIT	3171,4650,4660,5100.250,5100.251,5100.260 & 5100.261
TBJC60	60MM	TC/TC/TC/TC/VIT	3202,4670,4680,5100.300,5100.310,5150.300 & 5150.310
TBJC90	90MM	TC/TC/TC/TC/VIT	3301,5150.350 & 5150.360



Mechanical Seal For APV Pump	
TOPBON Type	PUMP Type
TB290	APV Puma Pumps
TB260	APV Puma Pumps
TB260A	APV Puma Pumps
TB160-25MM	APV W+ 10/8,22/20,30/80,35/35,35/55,50/8,55/35
TB160-35MM	APV W+ 25/210,30/120,30/180,55/60,60/110,65/350,70/40,80/80,110/130
TB160A	APV "Word" Pumps in single configuration
TB160B-25MM	APV W+ 10/8,22/20,30/80,35/35,35/55,50/8,55/35
TB160B-35MM	APV W+ 25/210,30/120,30/180,55/60,60/110,65/350,70/40,80/80,110/130





Mechanical Seal For O.E.M Pump	
TOPBON Type	PUMP Type
TB28	Common O.E.M Pumps
TBT50	INOXPA PROLAC and SLR Pumps
TBEMLL	E.M.U Pumps and Mixers



Mechanical Seal For FRISTAM Pump	
TOPBON Type	PUMP Type
TB208	FRISTAM FP/FL/FT
TB208/01	FRISTAM FP/FL/FT
TB208/1	FRISTAM FP/FL/FT
TB208/2	FRISTAM FP/FL/FT
TB208/11	FRISTAM FP/FL/FT
TB208/12	FRISTAM FP/FL/FT
TB208/11B	FRISTAM FP/FL/FT
TB208/12B	FRISTAM FP/FL/FT